

PHOTOVOLTAIC

GSE IN-ROOF SYSTEM™

BIPV system for photovoltaic panels

Installation manual - UNIVERSAL kit

V 11.3



CHUBB®



warringtonfire



GSE Integration

EUROPEAN LEADER IN PHOTOVOLTAIC INTEGRATION SYSTEMS



1	Kit presentation	4
1.1	Presentation of the GSE In-Roof System™	4
1.2	Contents of the kit	5
1.3	GSE PORTRAIT Frame	6
1.4	GSE LANDSCAPE Frame	7
1.5	GSE clamps	8
1.6	Tools required	9
2	Building site preparation	10
2.1	Climatic conditions	10
2.2	Position on the roof	10
2.3	Determine wind pressure of the project	11
3	Installation	12
3.0	Overall presentation of the system	12
3.1	Preparation of the roof covering	13
3.2	Positioning of the support battens	14
3.3	Sealing strip installation at bottom	16
3.4	GSE Frames installation	17
3.5	Lateral flashings installation	19
3.6	PV modules installation	21
3.7	Top flashings installation	25
3.8	Specific case : PV array with inner/outer angles	29
3.9	Connection to the roof covering	31
4	Maintenance and servicing	32
4.1	Verification	32
4.2	Module replacement	32
5	Assistance and contact	33
5.1	Training session	33
5.2	Technical assistance	33
6	Certifications and warranties	33
6.1	Technical assessments	33
6.2	Fireproofness test	33

1. Kit presentation

1.1 Integration system GSE In-Roof System™

GSE In-Roof System™ enables modules installation **on every type of roof covering (curved tiles, interlocking, flat tiles, slates, metal, zinc, trapezoidal)**, as well as on new buildings like retrofit buildings.

The mounting system may be installed in **a portrait or landscape** orientation, with a specific frame for each format, suitable for small installations (less than 3 kWp) and large roofs (ie dedicated manual).

GSE In-Roof System™ must be installed on the wooden or metallic substructure of the buildings and mounted on specific battens, adapted to climatic conditions. It can be mounted on slopes between **12° and 50°**.

Complementary manuals available :

- **GSE INTEGRATION In-Roof v. TS**
- **GSE INTEGRATION In-Roof v. A**
- **GSE INGRATION In-Roof v. TN**
- **GSE INTEGRATION In-Roof Industrial roofs**
- **GSE INTEGRATION In-Roof Roof-Windows**

You can also watch our installation video by clicking on the picture below:



Click on the picture to watch the video

Or you can find this video on our website by following this link:

<https://www.gseintegration.com/InRoof.html>

1.2 Contents of the kit

◆ MOUNTING FRAMES

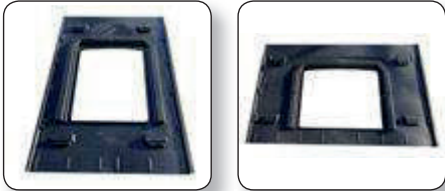

GSE Portrait Frame GSE Landscape Frame

◆ MOUNTING CLAMPS



Wood self-drilling screw 6,5 x 60

EPDM Foam

End clamp

Middle clamp

Edge wedges (L/R)

◆ FLASHINGS

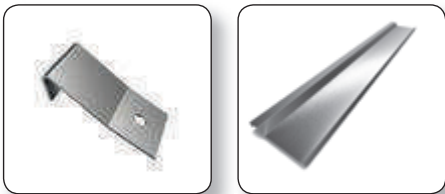

Flashing hook

Lateral flashing

OPTION 1



Top flashing

Attach angle

Aluminium pop rivet

Top flashing junction

Corner flashing

Sheet of zinc*

OPTION 2

* Not sourced by GSE

◆ WATERPROOFING



Flexalu TM or eq.

Sheet of zinc
* Not sourced by GSE

Lead tape
* Not sourced by GSE

Precompressed seal

HPV roof underlayment

1. Kit presentation

1.3 GSE PORTRAIT Frame

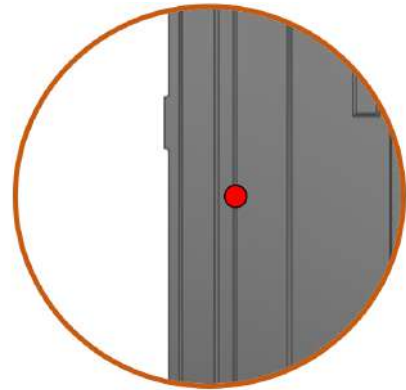
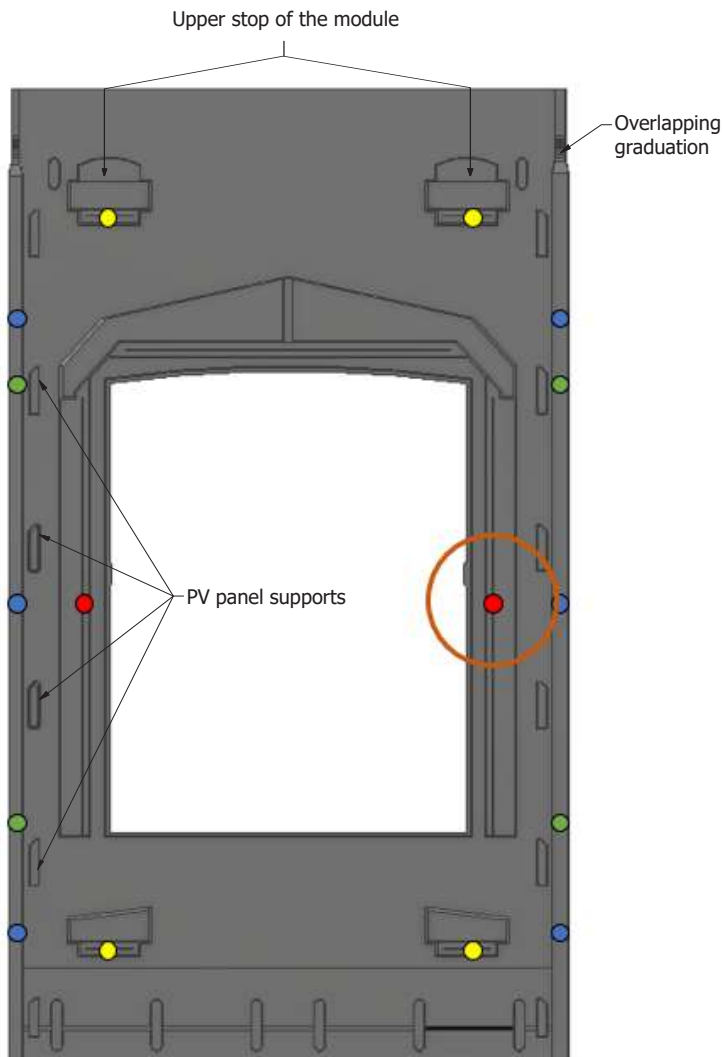

- Plate fixing point (**without pre-drilling**)
- Plate fixing point (**pre-drilling 10mm**)
- Clamp fixing point (6 clamps) (**pre-drilling 10mm**)
- Clamp fixing point (4 clamps) (**pre-drilling 10mm**)

Portrait frame references – Module sizes

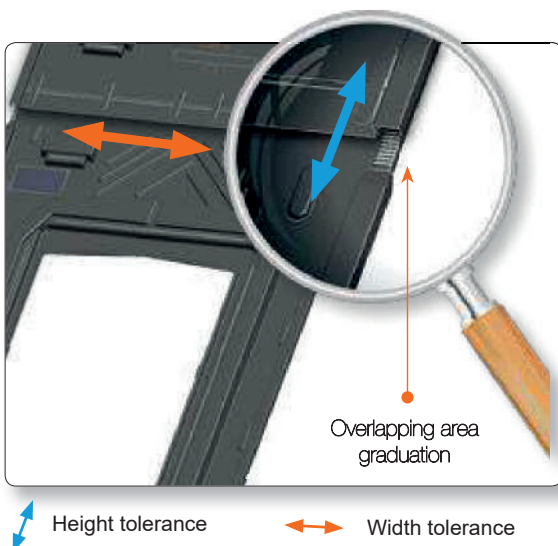

PV module dimensions

	Réf.	Height			Width	
		Min. tolerated	Min. suggested	Max.	Min. suggested	Max.
Version 2012	1580_808	1500	1540	1680	803	808
	1575_1046	1495	1535	1675	1041	1046
	1575_1053	1495	1535	1675	1048	1053
	1575_1082	1495	1535	1675	1077	1082
	1640_992	1560	1600	1740	987	992
	1640_1001	1560	1600	1740	996	1001
	1640_1001_33	1560	1600	1740	996	1001
Version 2020	1686-1700_1016	1605	1645	1755	1011	1016
	1710_995	1630	1670	1780	990	995
	1710_1000	1630	1670	1780	995	1000
	1710_1005	1630	1670	1780	1000	1005
	1710_1010	1630	1670	1780	1005	1010
	1710_1020	1630	1670	1780	1015	1020
	1710_1025	1630	1670	1780	1020	1025
	1710_1030	1630	1670	1780	1025	1030
	1710_1040	1630	1670	1780	1035	1040
	1710_1045	1630	1670	1780	1040	1045
1710_1050	1630	1670	1780	1045	1050	
1710_1055	1630	1670	1780	1050	1055	

1. Kit Presentation

1.4 GSE LANDSCAPE Frame

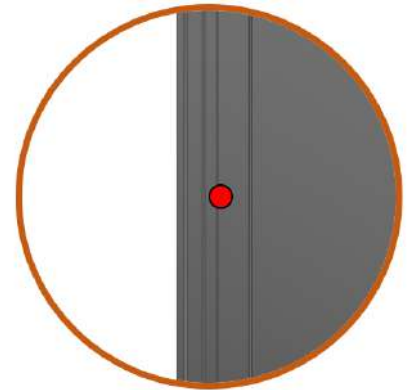
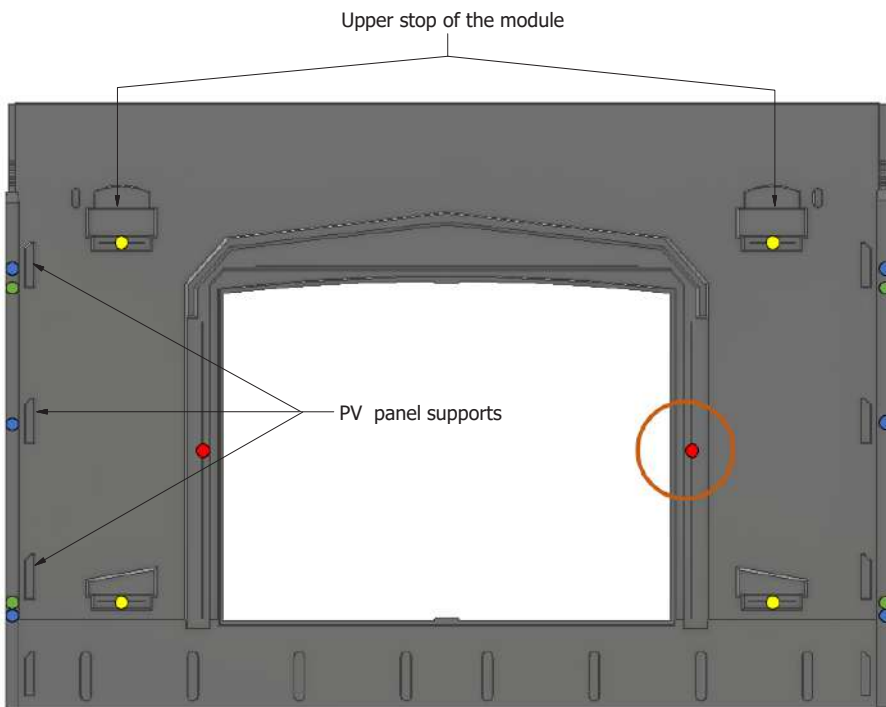

- Plate fixing point (**without pre-drilling**)
- Plate fixing point (**pre-drilling 10mm**)
- Clamp fixing point (6 clamps) (**pre-drilling 10mm**)
- Clamp fixing point (4 clamps) (**pre-drilling 10mm**)

Portrait frame references – Module sizes

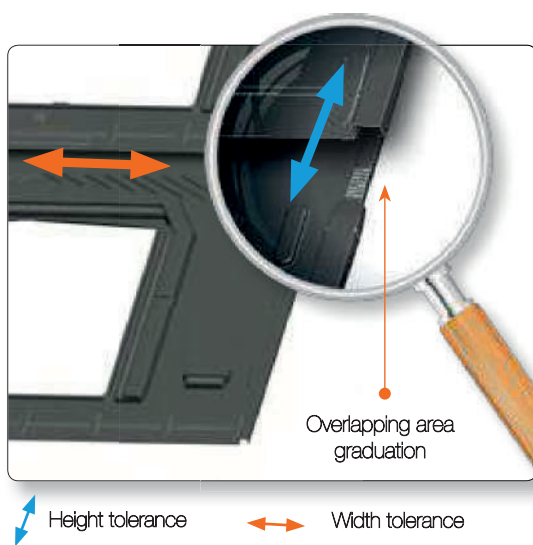

		PV module dimensions					
		Réf.	Height			Width	
			Min. tolerated	Min. suggested	Max.	Min. suggested	Max.
LANDSCAPE	Version 2012	1559_1082	1002	1042	1182	1554	1559
		1575_1082	1002	1042	1182	1570	1575
		1580_808	728	768	908	1575	1580
		1640_992	912	952	1092	1635	1640
		1650_992	912	952	1092	1645	1650
		1660_992	912	952	1092	1655	1660
		1670_992	912	952	1092	1665	1670
		1675_992_33	912	952	1092	1670	1675
		1680_992	912	952	1092	1675	1680
		1686_1016	912	952	1092	1681	1686
	1700_1016	912	952	1062	1695	1700	
	Version 2020	1665_1020	940	980	1120	1660	1665
		1675_1020	940	980	1120	1670	1675
1680_1020		940	980	1120	1675	1680	
1685_1020		940	980	1120	1680	1685	
1690_1020		940	980	1120	1685	1690	
1695_1020		940	980	1120	1690	1695	
1700_1020		940	980	1120	1695	1700	
1705_1020		940	980	1120	1700	1705	
1720_1020	940	980	1120	1715	1720		
1740_1020	940	980	1120	1735	1740		

1. Kit Presentation

1.5 GSE Clamps

◆ End clamp

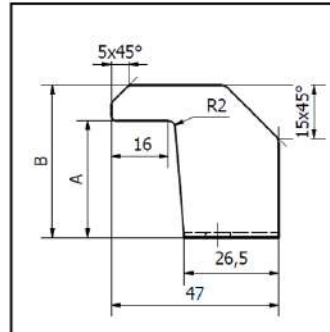

Description	A (mm)	B (mm)
End Clamp H16	17,8	27,8
End Clamp H19	20,8	30,8
End Clamp H21	22,8	32,8
End Clamp H23	24,8	34,8
End Clamp H26	27,8	37,8
End Clamp H27	28,8	38,8
End Clamp H31	32,8	42,8

◆ Middle clamp

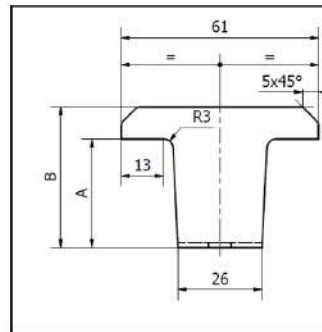

Description	A (mm)	B (mm)
Middle Clamp H16	18,6	28,6
Middle Clamp H19	21,6	31,6
Middle Clamp H21	23,6	33,6
Middle Clamp H23	25,6	35,6
Middle Clamp H26	28,6	38,6
Middle Clamp H27	29,6	39,6
Middle Clamp H31	33,6	43,6

◆ Correlation clamps / module thickness

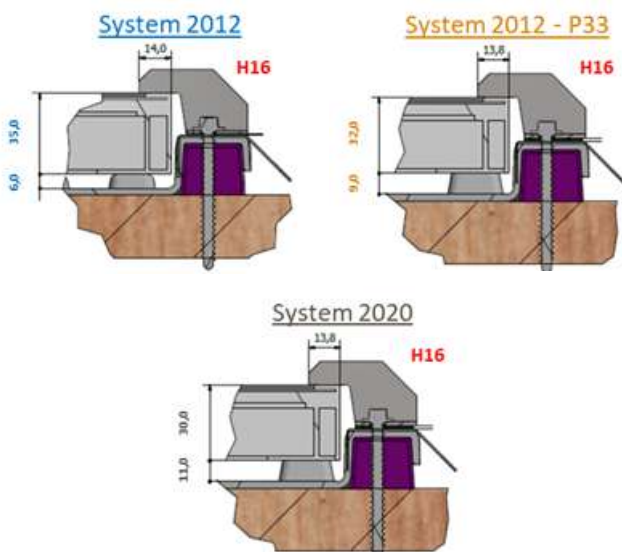

Clamps Size	Module thickness (mm)		
	GSE In-Roof V2012	GSE In-Roof V2012 – P33	GSE In-Roof V2020
H16	35-37 mm	32-34 mm	30-32 mm
H19	38-39 mm	35-36 mm	33-34 mm
H21	40-41 mm	37-38 mm	35-36 mm
H23	42-44 mm	39-41 mm	37-39 mm
H26	45-46 mm	42-43 mm	40-41 mm
H27	47-48 mm	44-45 mm	42-43 mm
H31	50 mm	47-49 mm	45-47 mm

INFO : Find the complete table of correlation on our website by following this link:
https://www.gseintegration.com/Docs/Intl/EN/IR_EN_EVOLUTION.pdf

1. Kit Presentation

1.6 Tools required

◆ SCREWDRIVER



Adjustable tightening torque mandatory

◆ DRILL BITS WOOD AND METAL OF 10MM



◆ HEX BIT 8MM



◆ AVIATION SNIP



◆ RIVET GUN



◆ HAMMER



◆ MEASURING TAPE

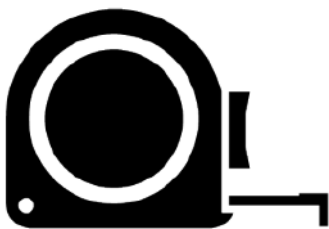

◆ CHALK LINE



◆ MARKING ACESSORIES



White marker, pencil, etc.

2. Building site preparation

The installer must proceed to a measurement work beforehand, in order to guarantee the durability and performance of the PV array installed. Climatic conditions of the project (ie. wind and snow¹) and PV array layout should be considered according to current regulations (Eurocodes and BS 5534).

This data will help check if the system is suitable for the project conditions. The thickness of the support battens must be adapted to the roof battens to ensure the junction with the roof covering is watertight.

2.1 Climatic Conditions

Climatic load according to Eurocode 1 and BS 5534 :



Geographical wind zone	Wind speed (m/s)	Design Wind Pressure (kN/m ²)
1	22	0,820
2	24	0,975
3	26	1,150
4	28	1,330
5	30	1,600

Maximum design wind uplift resistance: **2,71 kN/m²**
(According to MCS 012 BBA 0156 certificate)

2.2 Position on the roof

The location of the PV array has an influence on the wind load value whether it is in the center, on the edge or in the corner of the roof. The worst case should be taken into account.

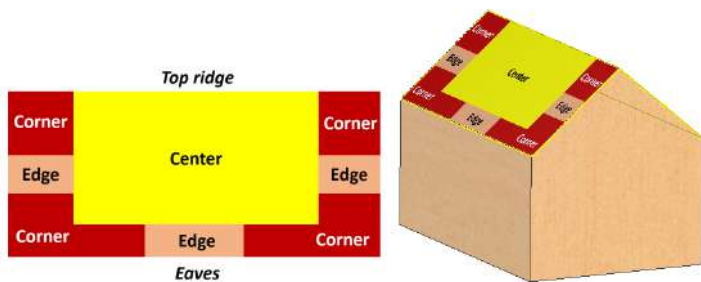

Two-sloped roof

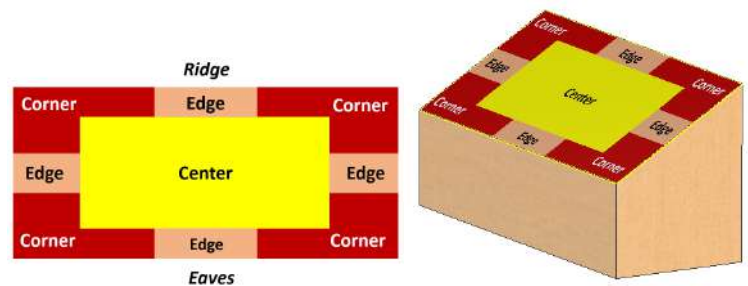

One-sloped roof

¹ The seismic resistance of the GSE In-Roof System is validated on the whole European territory.
 This criterion is not to be taken into account.

2. Building site preparation

2.3 Determine wind pressure of the project

To calculate the wind load on the PV array, you need to priorly know the following parameters:

- Location of the project
- Altitude
- Type of terrain
- Distance from the shoreline
- Ridge height
- Roof pitch
- Roof zone (Center, Edge, Corner)

Ideally, climatic load (and especially wind load) should be calculated for each project, but you can refer to the tables below, if all conditions matches with those of the project.

Fixed conditions :

- Terrain category : **Country terrain** (including Town Terrain)
- Distance from the shoreline : **10 km**
- Battens dimension : **25 x 50mm**

1st case : Roof pitch $\geq 25^\circ$

Ridge Height	Location on the Roof	Zone 1 (Alt $\leq 250m$)	Zone 2 (Alt $\leq 200m$)	Zone 3 (Alt $\leq 130m$)	Zone 4 (Alt $\leq 100m$)	Zone 5 (Alt $\leq 50m$)
6 m	Center	1,26 kN	1,38 kN	1,44 kN	1,58 kN	1,65 kN
	Edges	1,46 kN	1,60 kN	1,67 kN	1,83 kN	1,92 kN
	Corners	1,56 kN	1,72 kN	1,78 kN	1,96 kN	2,05 kN
8 m	Center	1,37 kN	1,51 kN	1,57 kN	1,72 kN	1,80 kN
	Edges	1,59 kN	1,75 kN	1,82 kN	2,00 kN	2,09 kN
	Corners	1,71 kN	1,87 kN	1,95 kN	2,14 kN	2,24 kN
10 m	Center	1,43 kN	1,57 kN	1,63 kN	1,79 kN	1,88 kN
	Edges	1,66 kN	1,82 kN	1,90 kN	2,08 kN	2,18 kN
	Corners	1,78 kN	1,95 kN	2,03 kN	2,23 kN	2,33 kN

2nd case : Roof pitch $\geq 35^\circ$

Ridge Height	Location on the Roof	Zone 1 (Alt $\leq 250m$)	Zone 2 (Alt $\leq 200m$)	Zone 3 (Alt $\leq 150m$)	Zone 4 (Alt $\leq 100m$)	Zone 5 (Alt $\leq 50m$)
6 m	Center	1,09 kN	1,19 kN	1,29 kN	1,36 kN	1,43 kN
	Edges	1,36 kN	1,49 kN	1,61 kN	1,71 kN	1,78 kN
	Corners	1,43 kN	1,57 kN	1,69 kN	1,79 kN	1,87 kN
8 m	Center	1,19 kN	1,30 kN	1,40 kN	1,49 kN	1,56 kN
	Edges	1,48 kN	1,63 kN	1,75 kN	1,86 kN	1,95 kN
	Corners	1,56 kN	1,71 kN	1,84 kN	1,95 kN	2,04 kN
10 m	Center	1,24 kN	1,36 kN	1,46 kN	1,55 kN	1,62 kN
	Edges	1,55 kN	1,69 kN	1,83 kN	1,94 kN	2,03 kN
	Corners	1,62 kN	1,78 kN	1,92 kN	2,04 kN	2,13 kN

3. Installation

3.0 Overall presentation of the system

Overall presentation of the installation of the kit:

- 1 Positioning of the support battens
- 2 GSE frames installation
- 3 Flashings installation
- 4 PV modules installation
- 5 Connection to the roof covering on top, bottom and lateral PV field

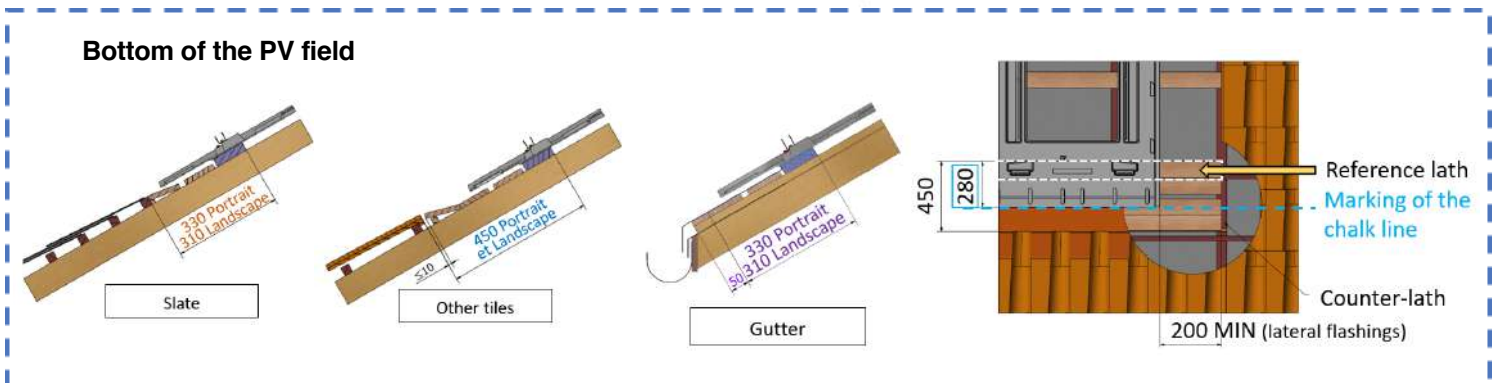
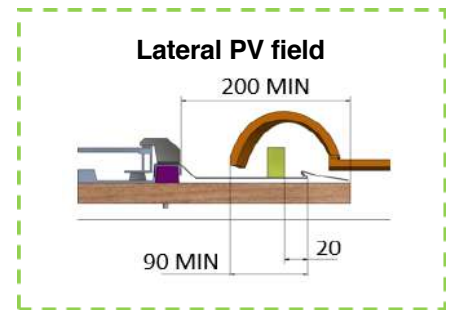
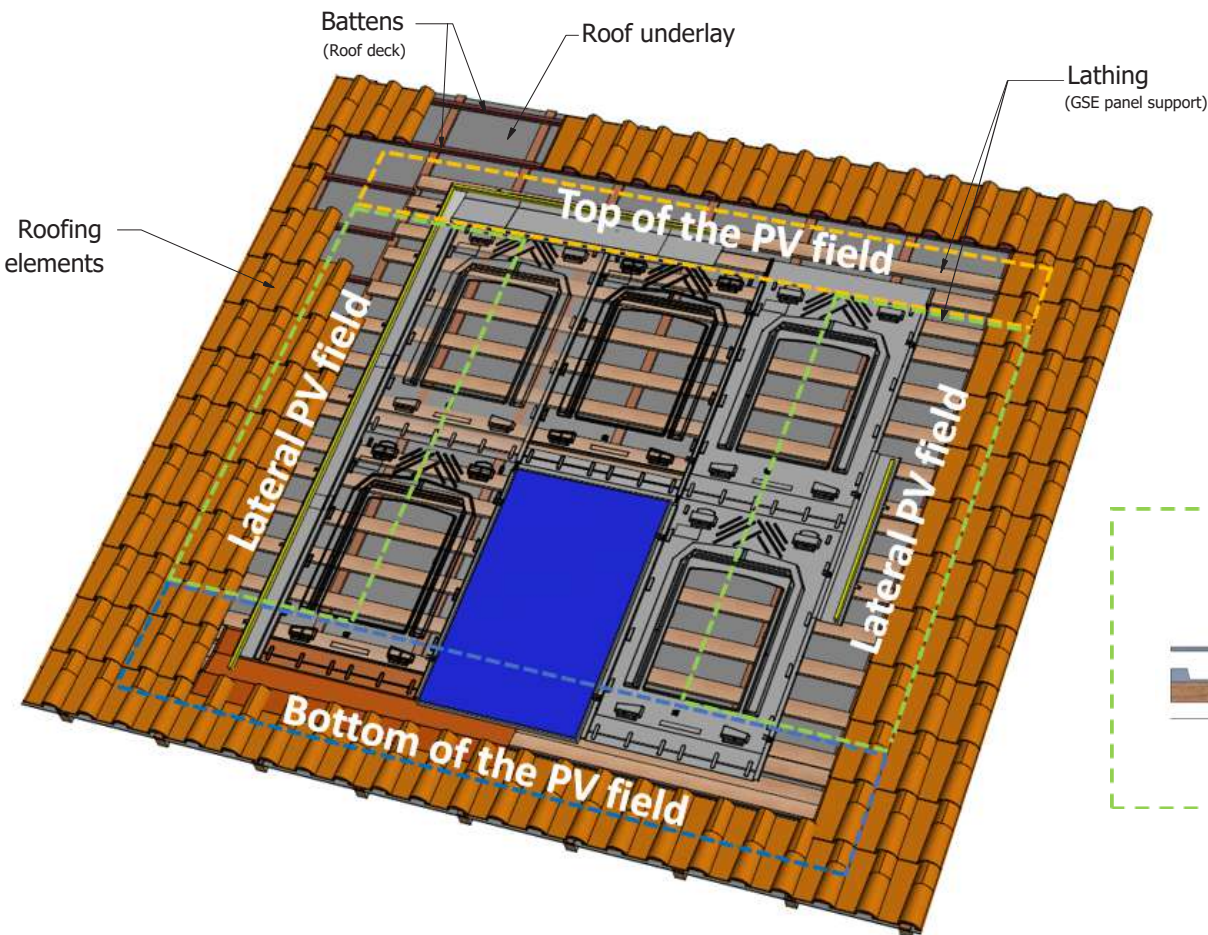
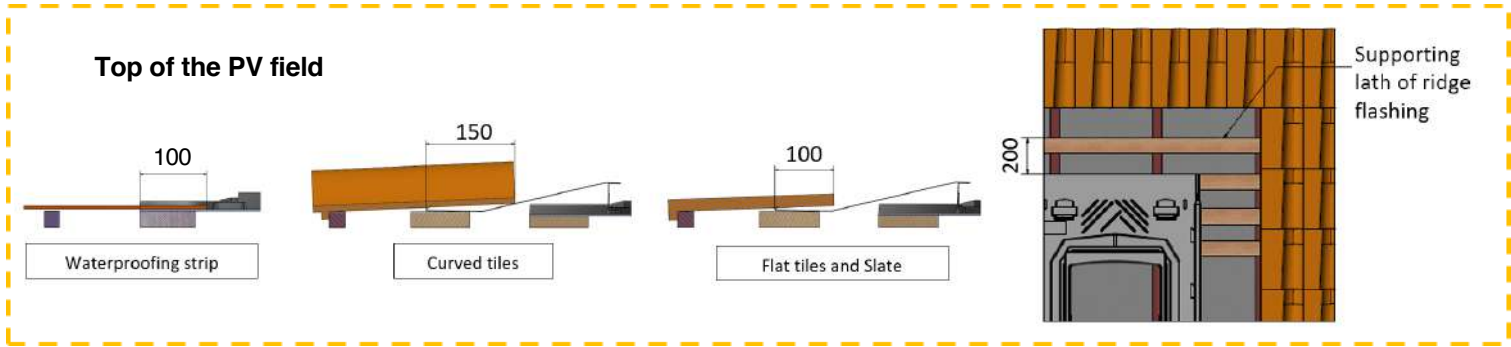

3.1 Preparation of the roof covering

3.1.1 Calculation of the PV array dimensions

INFO: Download our layout calculator on the « Download & Media » section of our website www.gseintegration.com to determine the dimensions of your PV array.

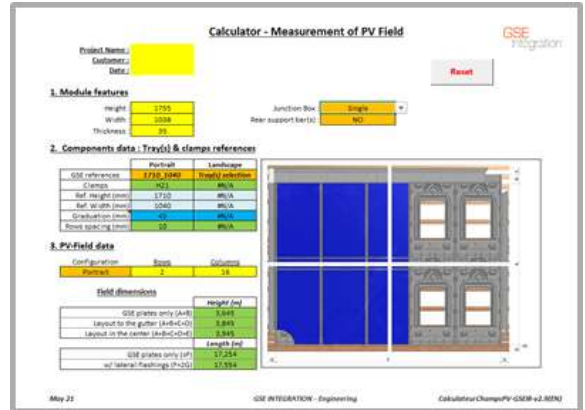

The dimensions of the PV array can be calculated using the GSE frame reference (see sections 1.3 and 1.4 to determine the GSE frame compatible with the module):

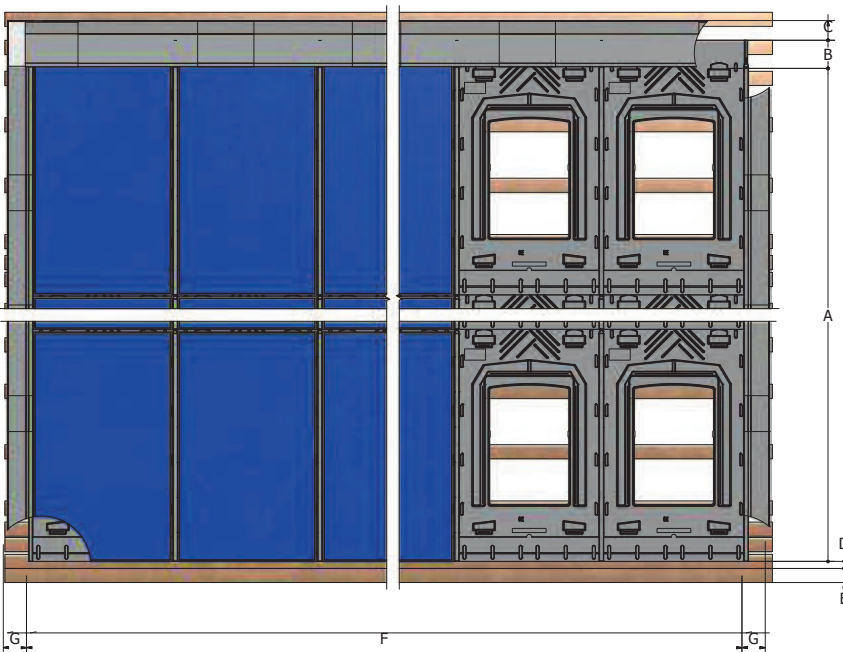

Array height (mm) =

$$((\text{Height Ref.} + 0 \text{ to } 35 + 10) \times \text{Nb. lines}) + 160 + 150 + 50 + 100^2$$

$$A + B + C + D + E$$

Array width (mm) =

$$((\text{Width Ref.} + 36.5) \times \text{Nb. columns}) + (2 \times 165)$$

$$F + 2 \times G$$

2 If integrated in the roof center, add a board to equalise with the tile curve height (ie. 3.3)

GSE frames - PORTRAIT

Height Ref	1580	1575	1575	1575	1640	1640	1686	1710	1710	1710	1710	1710	1710	1710	1710	1710	1710	1710	1710
Width Ref	808	1046	1053	1082	992	1001	1016	995	1000	1005	1010	1020	1025	1030	1040	1045	1050	1055	

GSE frames - LANDSCAPE

Height Ref	1082	1082	808	992	992	992	992	992	992	992*	992*	1020	1020	1020	1020	1020	1020	1020	1020	1020	
Width Ref	1559	1575	1580	1640	1650	1660	1670	1675	1680	1686	1700	1665	1675	1680	1685	1690	1695	1700	1705	1720	1740

*Landscape frames 1686_1016 and 1700_1016 have a reference height of 992.

3.1.2 Roof cover installation

Remove the roofing elements following the PV array dimensions (calculated beforehand), and by removing 1 or 2 extra tile lines (slate or flat tile) on the lateral sides and top of the array.

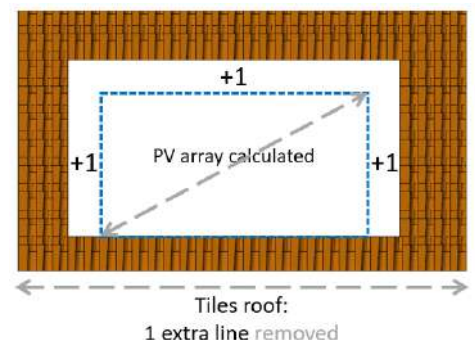
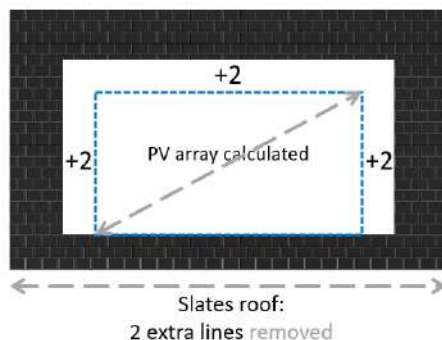

3. Installation

3.2 Positioning of the support battens

WARNING: PRIOR TO STARTING ANY WORK, THE INSTALLER MUST ENSURE THAT THE FRAMEWORK IS FLAT AND THERE MUST BE A ROOF UNDERLAY ACCORDING TO THE BUILDING STANDARD BS 5534.

1. Determine beforehand the number of fixing clamps and the adapted batten section (see section 2).
2. Dispose the wooden battens to the following locations:
 - Fixing points of the clamps
 - Fixing points of the frames
 - Junction between the frame rows (3)
 - Support of the sealing strip (3)
 - Mounting hooks of top flashings (3)

Battens fixing: It is recommended to use self-drilling wood screw of 5x80mm

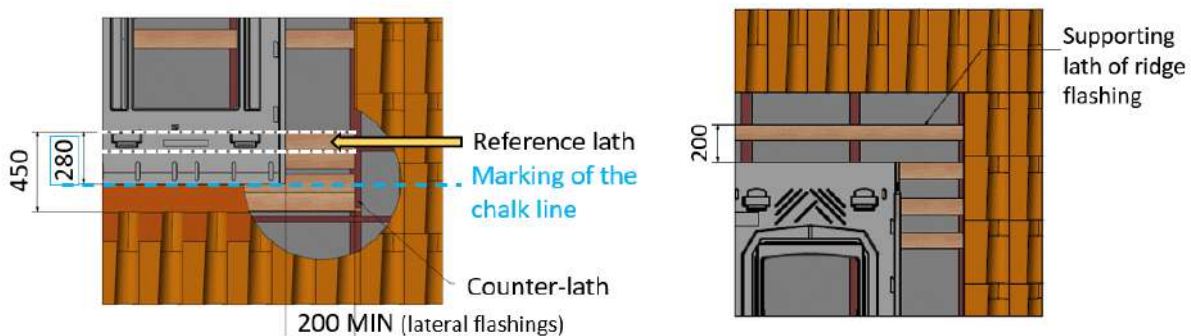
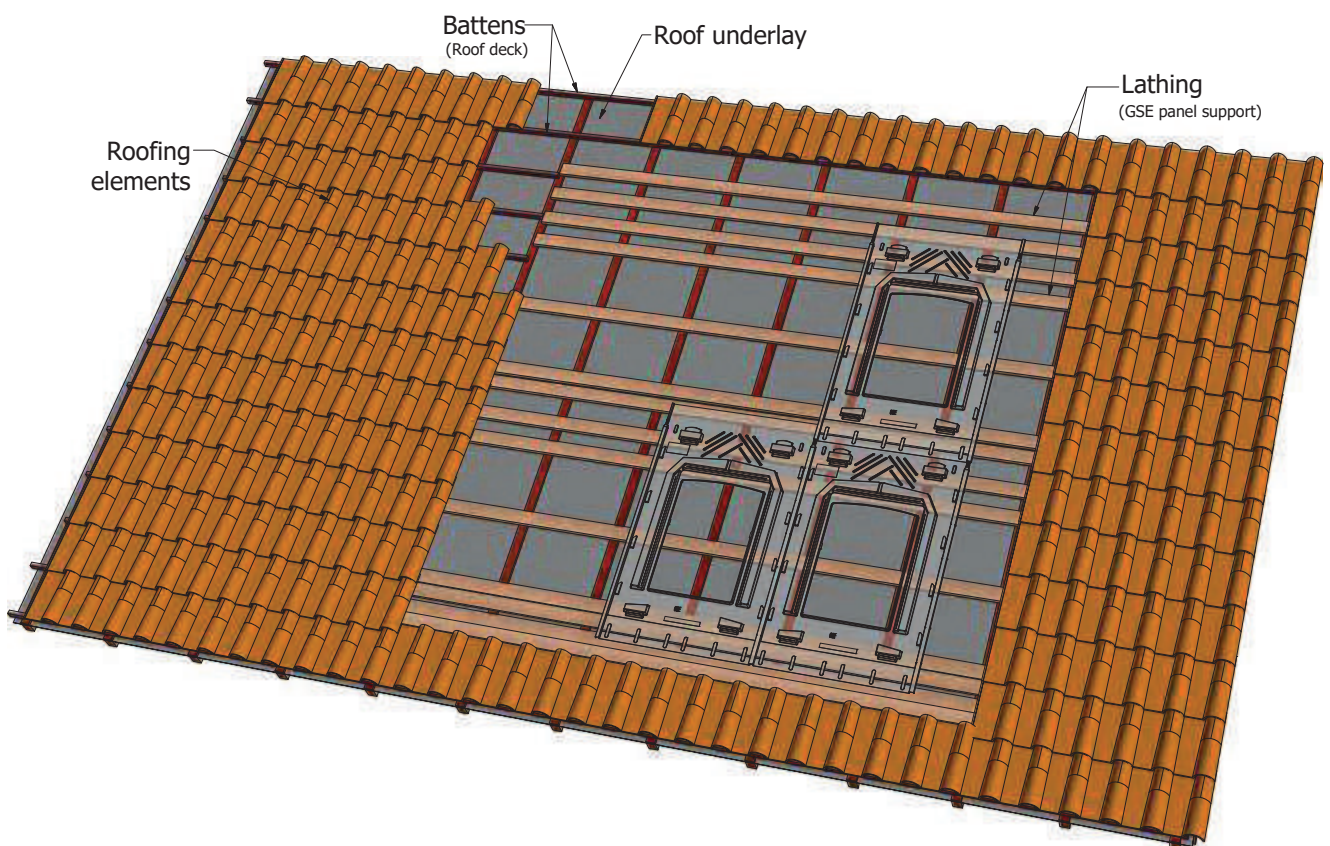

WARNING: THE POSITION OF THE FIXING CLAMPS AND THEIR SUPPORT BATTENS MUST COMPLY WITH MODULE MANUFACTURER REQUIREMENTS.

(3) Since these elements play no role in the mechanical system strength, the width of the timber could be different from that calculated for the fixing clamps. Only the thickness should be identical.

3. Installation

All of our battening plans in PORTRAIT and LANDSCAPE configuration are available on our site www.gseintegration.com/Docs/Intl/EN/IR_EN_PL.pdf

Example of battening plans for **PORTRAIT** frames with a reference height of **1710 mm** and **4 fixing clamps** :

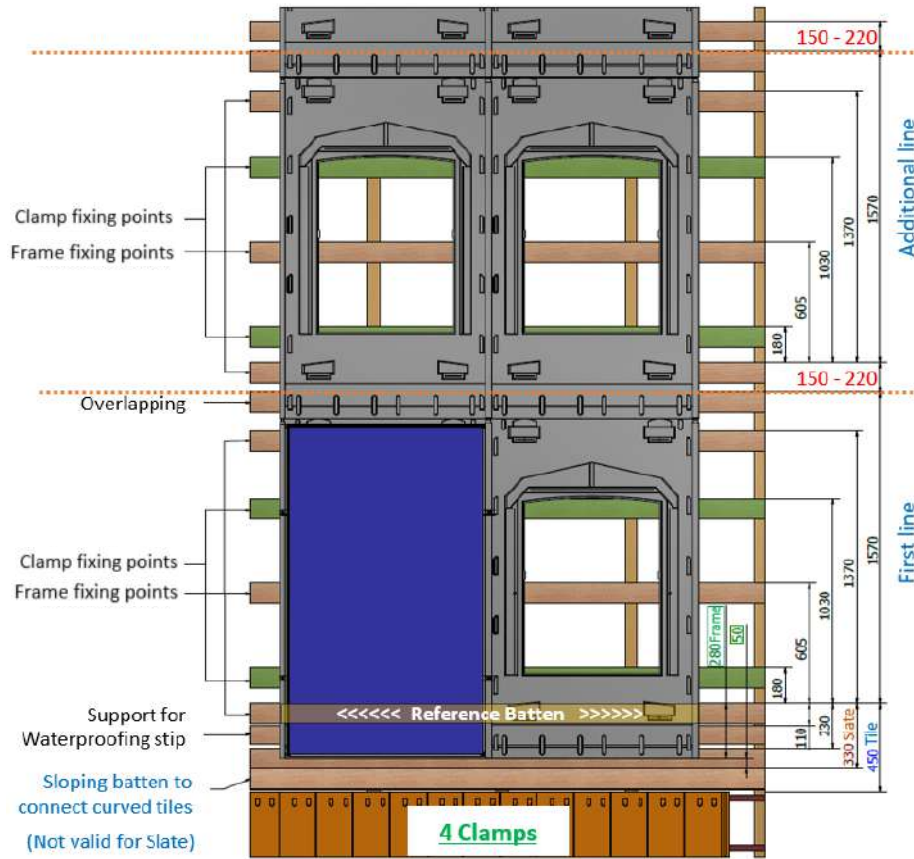

Example of battening plans for **LANDSCAPE** frames with a reference height of **1020 mm** and **4 fixing clamps** :



3. Installation

3.3 Sealing strip installation

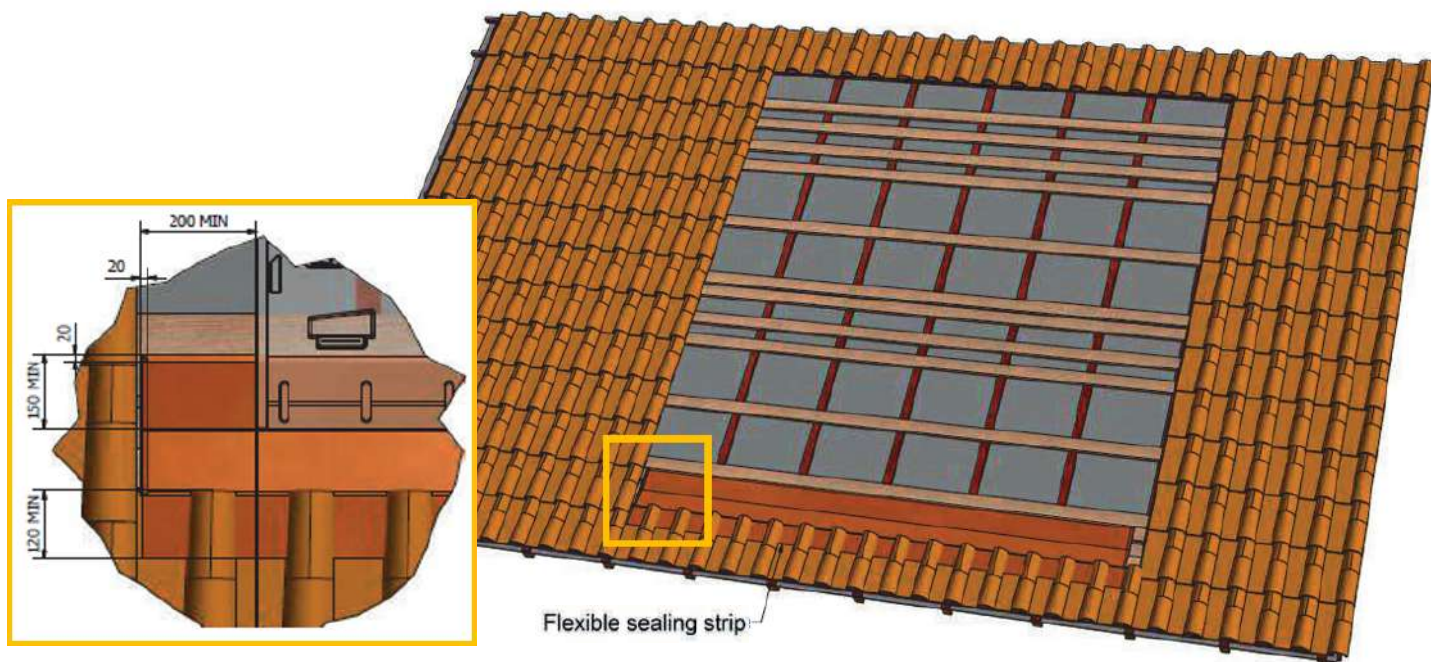

The sealing strip is laid out to link up with the bottom part of the roofing (PV array in the middle of the roofing).

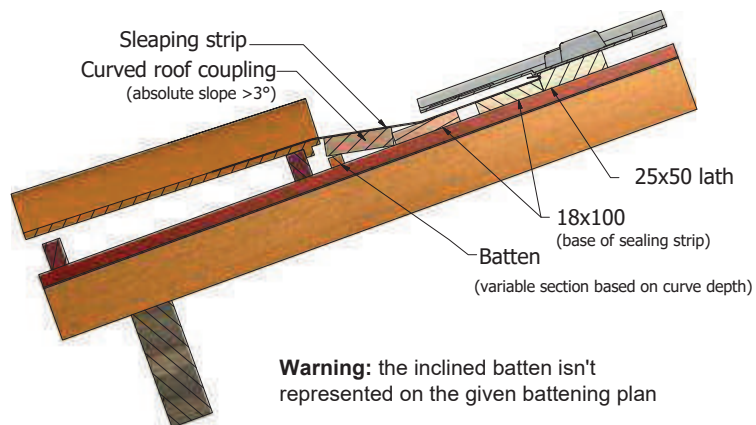

A batten is placed to fit with the thickness of the roof tile and to provide a flat base for the sealing strip.

WARNING:
ALWAYS MAINTAIN A MINIMUM SLOPE OF 3°

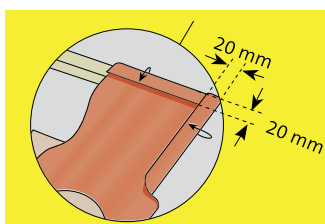

When installing the sealing strip on tiles with relief, make sure to press it down well so that it follows the roof tile's shape correctly. Make a 20-mm fold on the top part and sides to prevent water upwelling. Put spots of glue every 50cm when installing in heavy rain / high wind areas.

3. Installation

When installing all the way to the eaves, the sealing strip is laid out in a way as to connect directly to the gutter.

The connection of the waterproofing strip to the gutter can be done with a drip flashing: one for the PV field, another one for the roof underlayment.

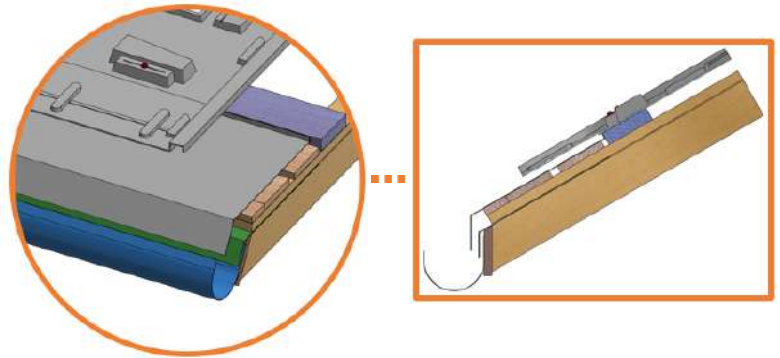
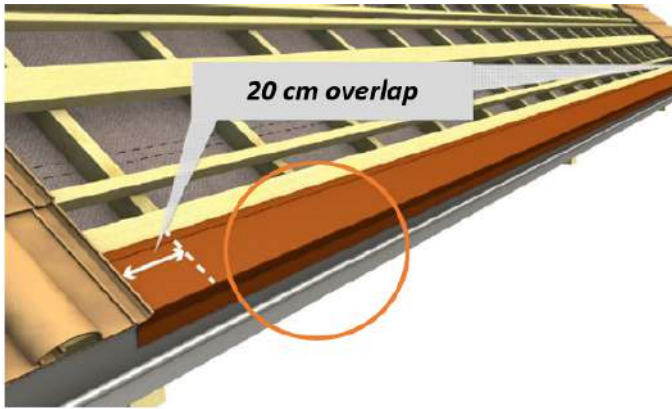

3.4 GSE Frames installation

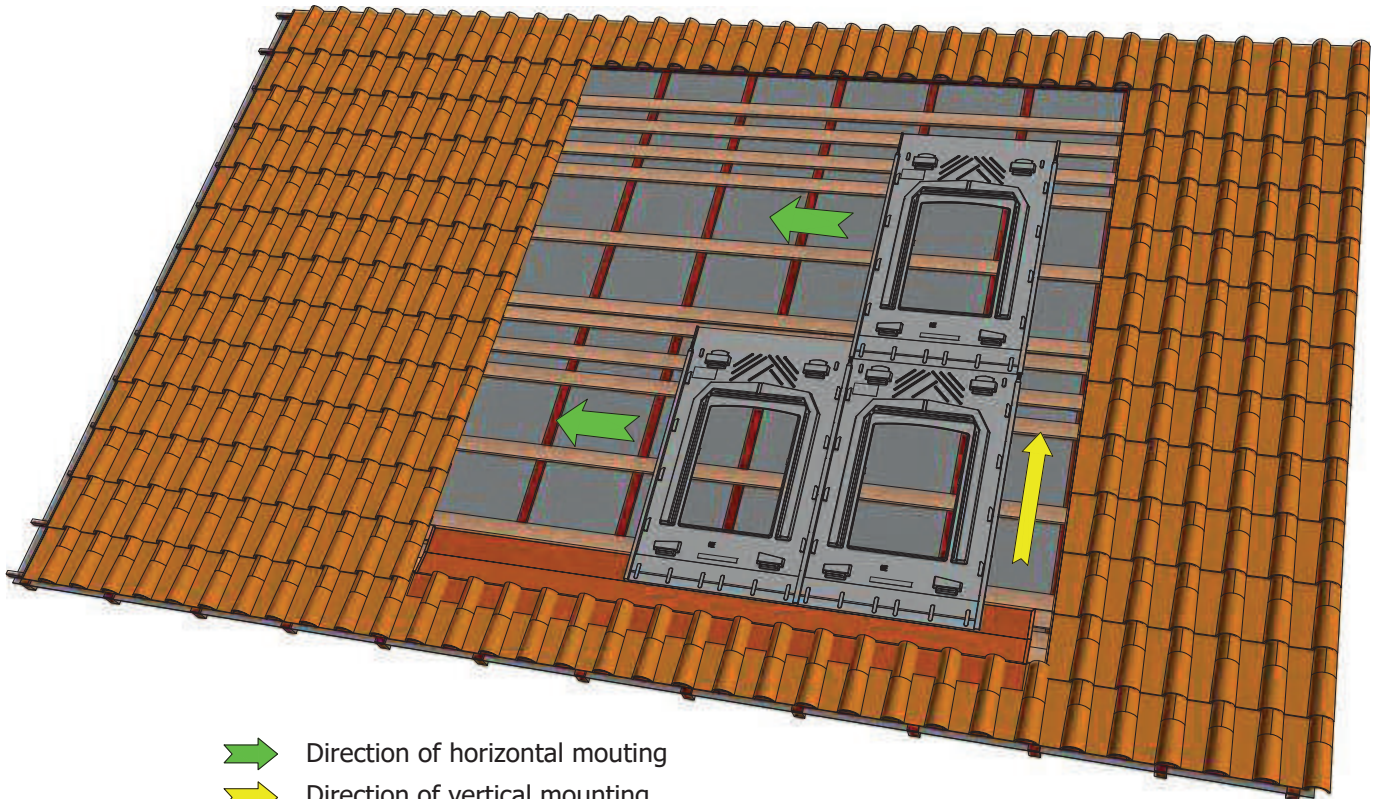

1 Draw a chalk line along the bottom of the first row, in the middle of the reference lath.

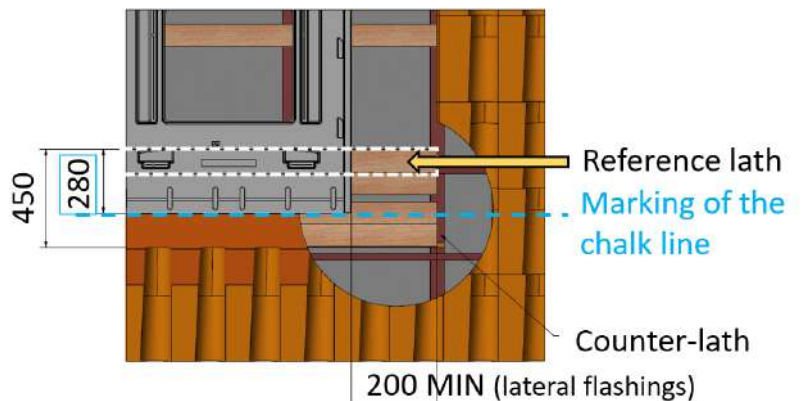

3. Installation

2 Interlock the plastic frames from the right to the left side (left interlocking is well done)

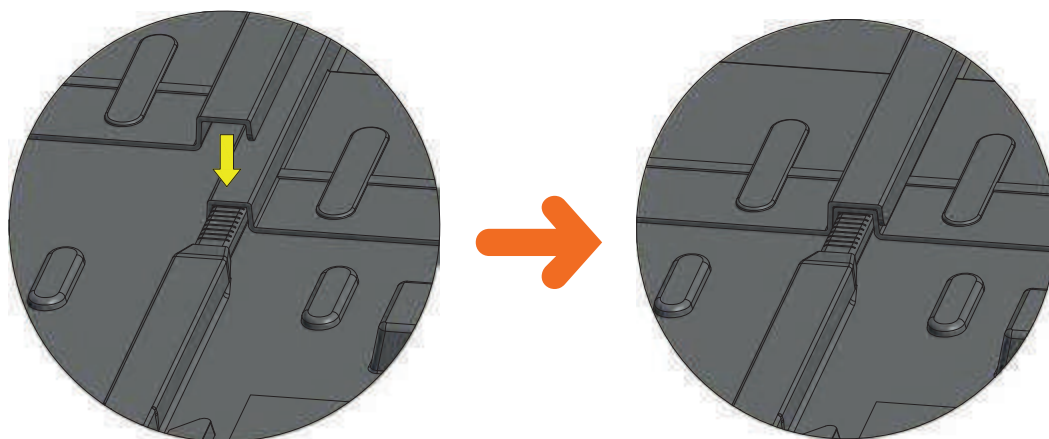

3 Attach the panels only by the reference points.

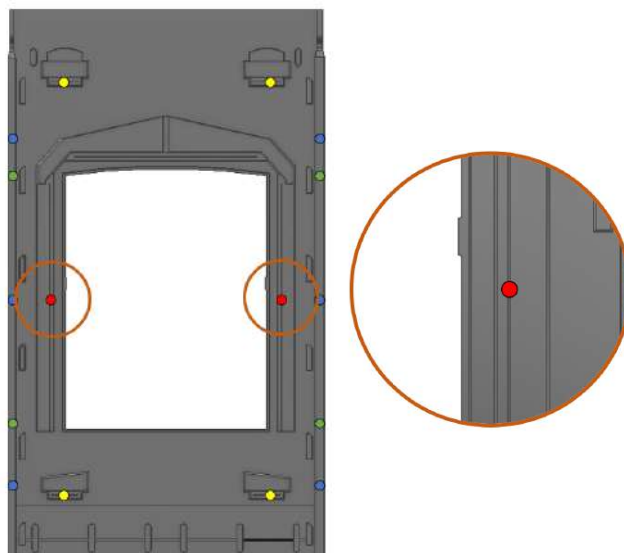
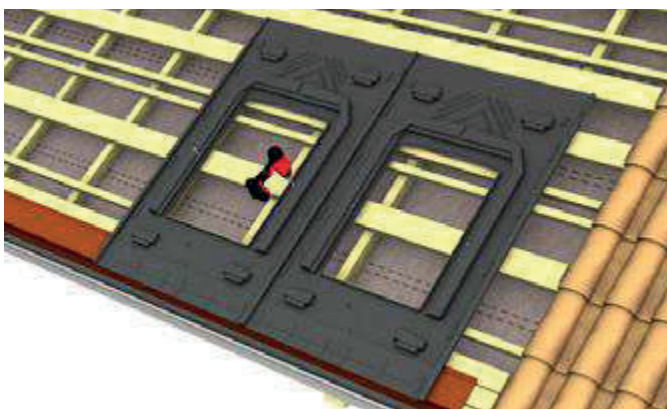

WARNING: WHEN INSTALLING THE UPPER ROWS, ADJUST SO THAT ONE ROW COVERS THE OTHER USING THE GRADUATIONS BASED ON THE LENGTH OF THE MODULE (IE DEVICE).

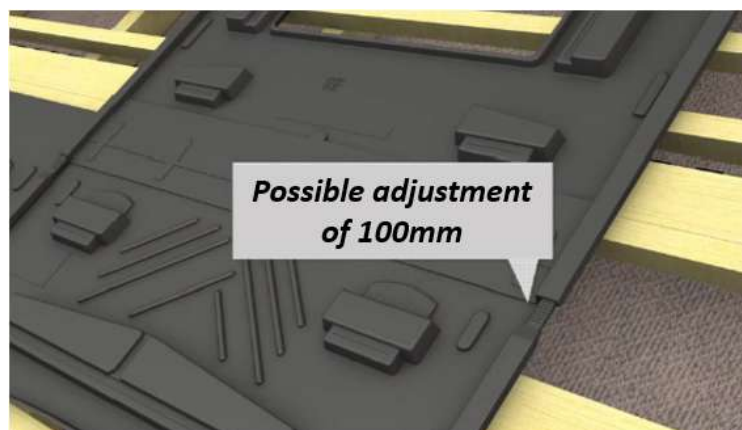

3. Installation

3.5 Lateral flashings installation

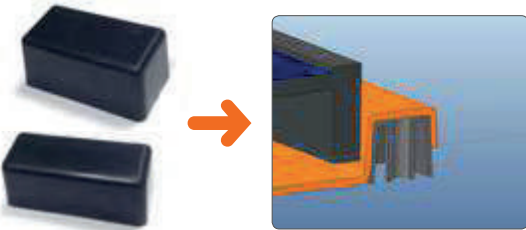
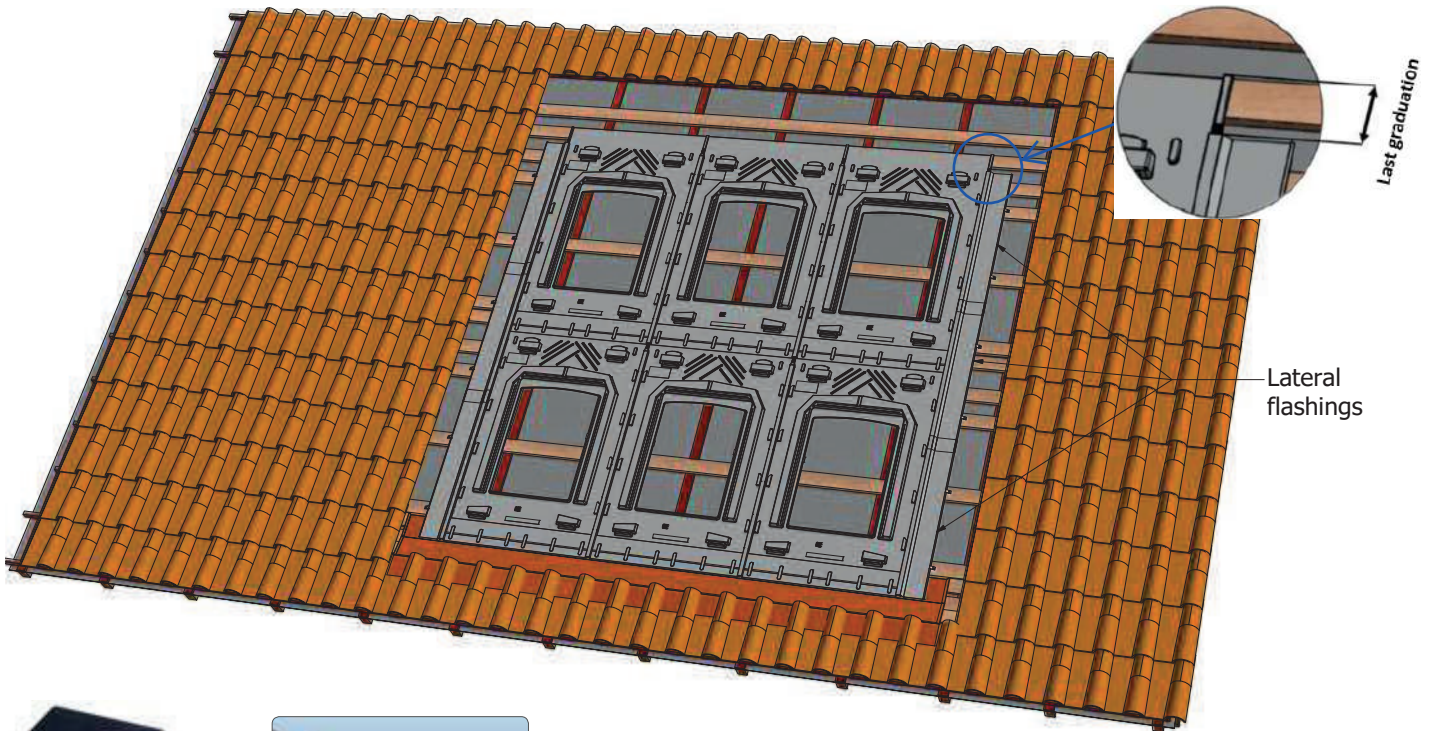

WARNING : BEFORE INSTALLING THE LATERAL FLASHINGS, MAKE SURE TO PLACE THE WEDGES AT THE ARRAY ENDS, UNDER THE CORRUGATIONS, WHERE THE END CLAMPS ARE LOCATED.

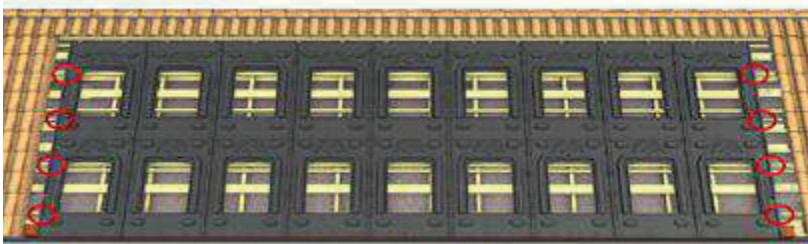

TIP:
Mark their position on the inner surface of the panel to identify them after positioning the lateral flashings.

- 1 Place the lateral flashings of the low end of the first row of panels, up to 120 mm of the upper edge of the last row. The overlap between two parts of the lateral flashing will be at least 150 mm. Each will be held in place by at least 2 attachment hooks.

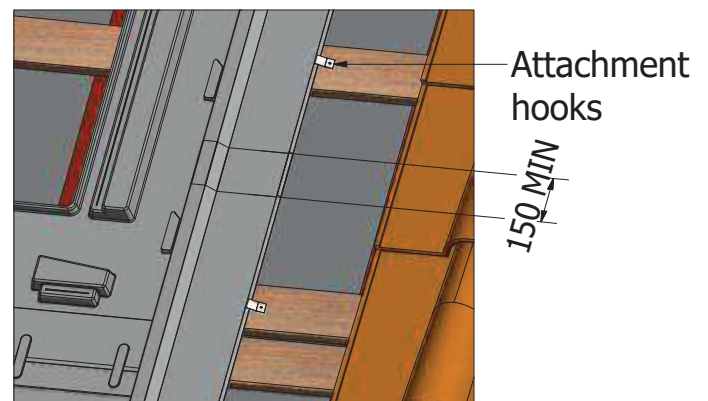

3. Installation

2 Carry out the pre-drilling using a 10 mm wooden drill bit on the 4 remaining attachment points of the GSE frame.

Tip: It is possible to pre-drill the expanding points of the frame before mounting on the roof. The frames are drilled individually (do not drill several frames at the same time).

Pre-drill



Screw



3 Then, pre-drill the fixing points of the clamps.



4 For end clamps, pre-drill through the flashing, the frame's corrugation and the wedges.



Reminder : It is prohibited to drill in the outflow zones and at the high points of the GSE frame. It may compromise the integrity of the photovoltaic system and its watertightness.

Please refer to the plans page 6 & 7 for the location of the fixing points.

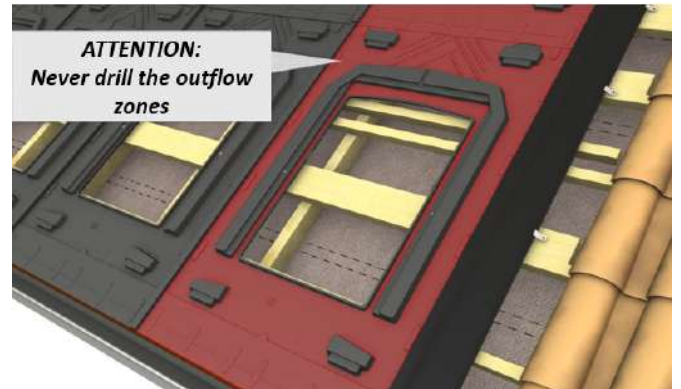

3. Installation

3.6 PV modules installation

3.6.1 Cabling preparation

Example of wiring diagram with installation of micro-inverters:

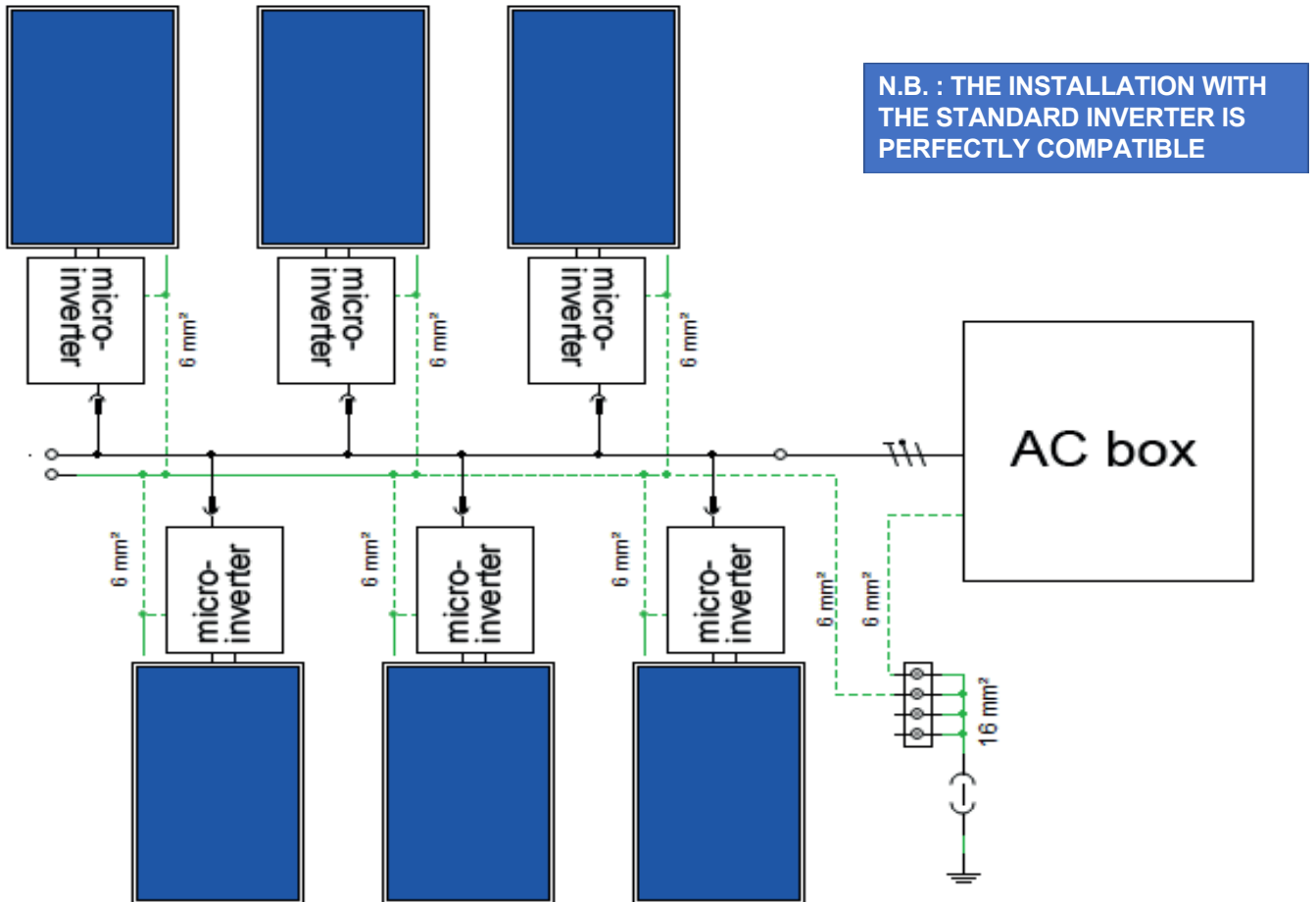

Position the module in such a way that the cables of the junction box pass through the designated space.



TIP: Some module manufacturers allow portrait orientation setting with the junction box going downwards. Please refer to the manufacturer's guidances.



Modules with splitted junction box are only compatible with the 2020 frames

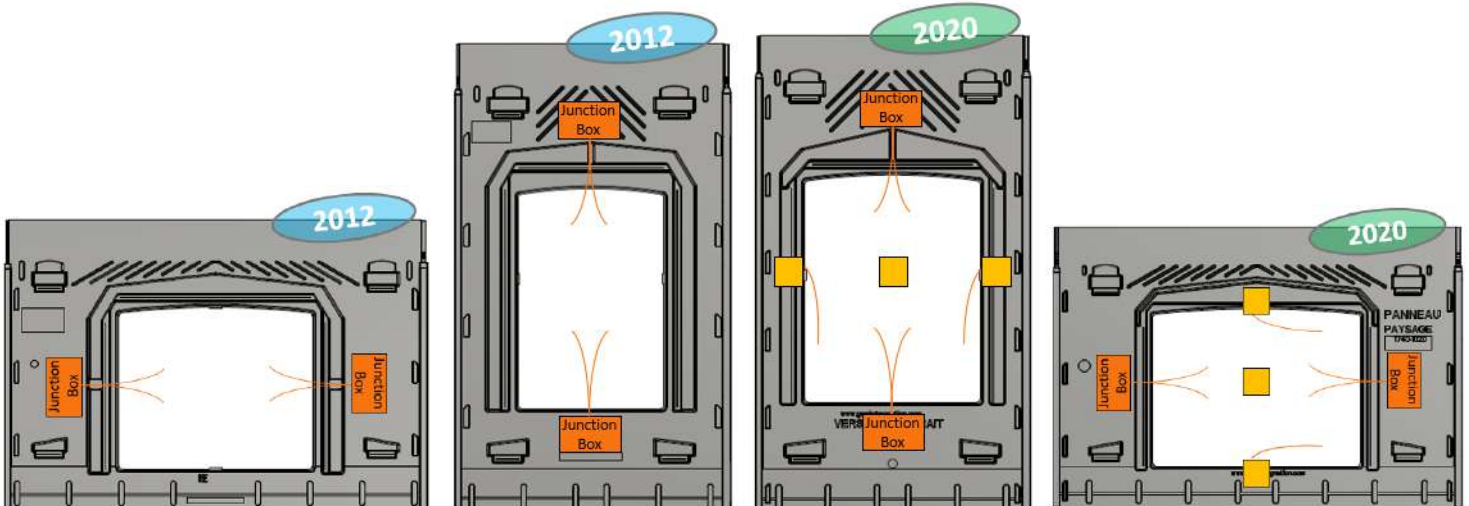

3. Installation

When using micro-inverters, attach them to a lath at the level of the GSE frame's central hole.

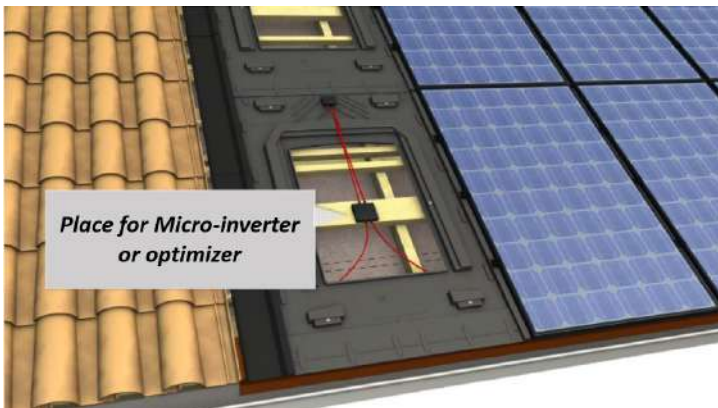

WARNING: PLEASE REFER TO THE INVERTER'S MANUAL TO BE SURE THAT THE INSTALLATION COMPLY WHY THE MANUFACTURER RECOMMENDATIONS

✓ Compatibility with all micro-inverters and optimizers on the market

Passage of grounding cables:

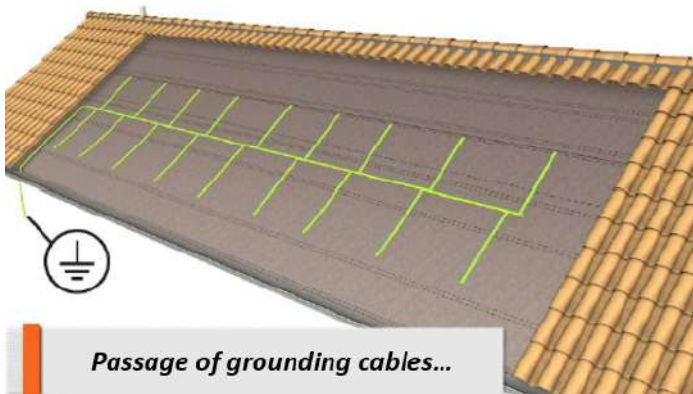

WARNING: WHEN SETTING UP THE CABLES, MAKE SURE YOU DO NOT CREATE ANY INDUCTION LOOP, IN ACCORDANCE WITH REGULATION.

Grounding of the frame of the modules and of the micro-inverter (please refer to the implementation requirements of manufacturers) :



Connection of the ground cable under the panel



WARNING: MAKE SURE THAT ALL CABLE PASSAGES ARE KEPT ON THE FRAME USING CABLE CLAMPS.

3. Installation

3.6.2 PV modules installation

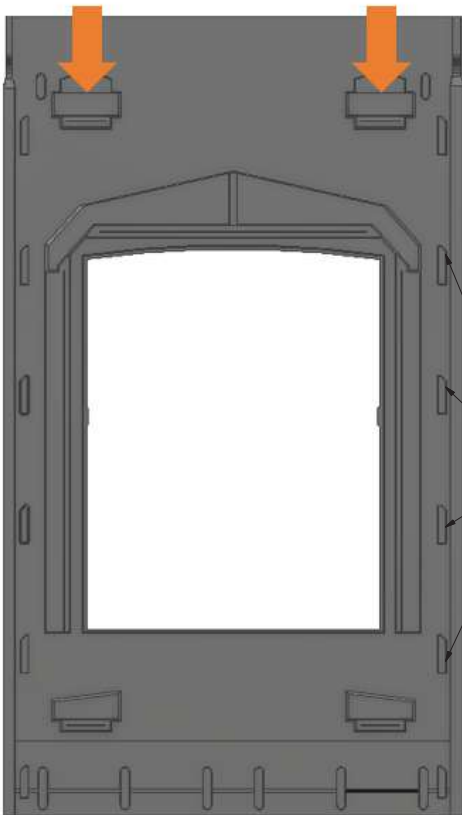
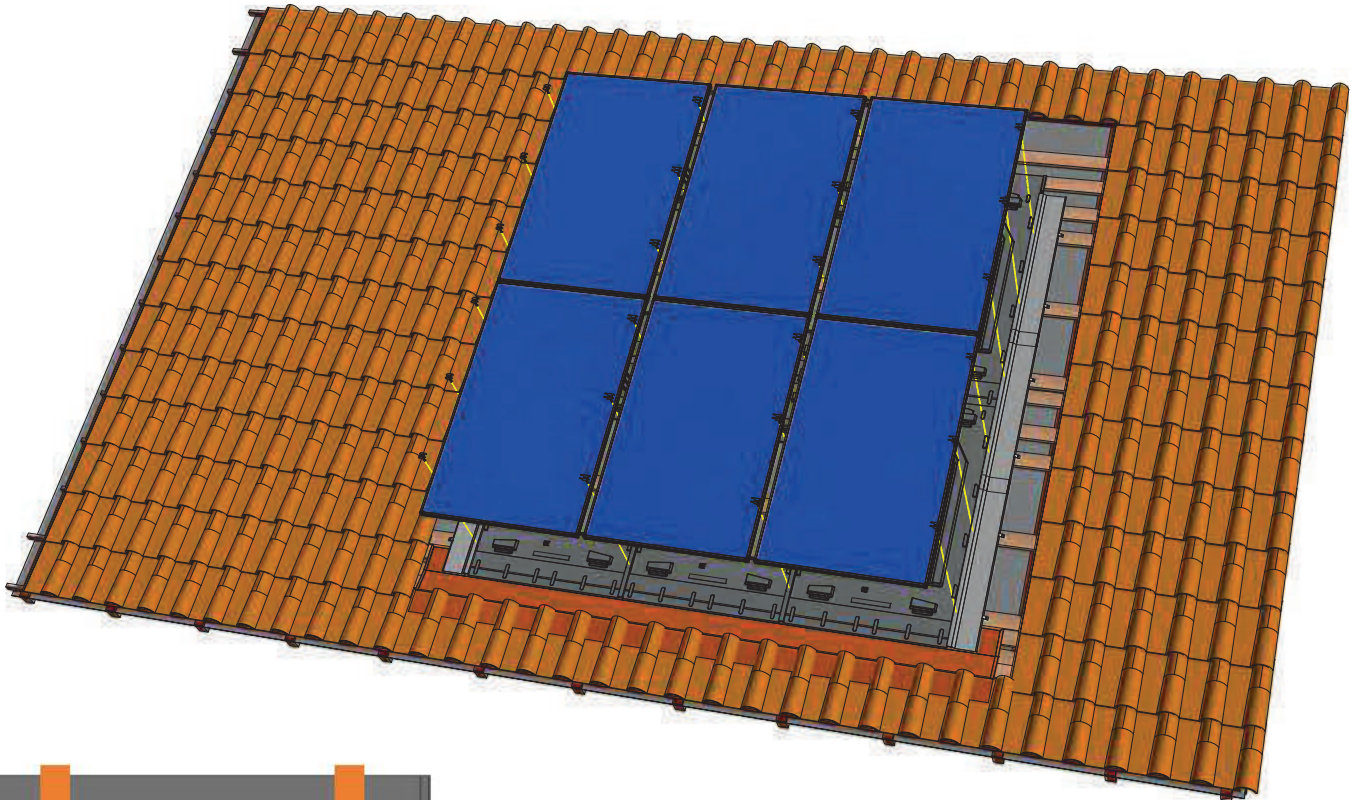

Position the modules in such a way that they're resting on the support pads and abut against the upper pads (orange arrows).

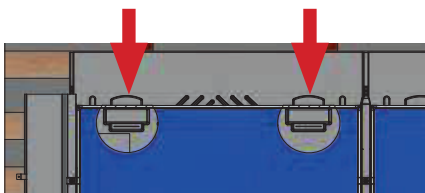
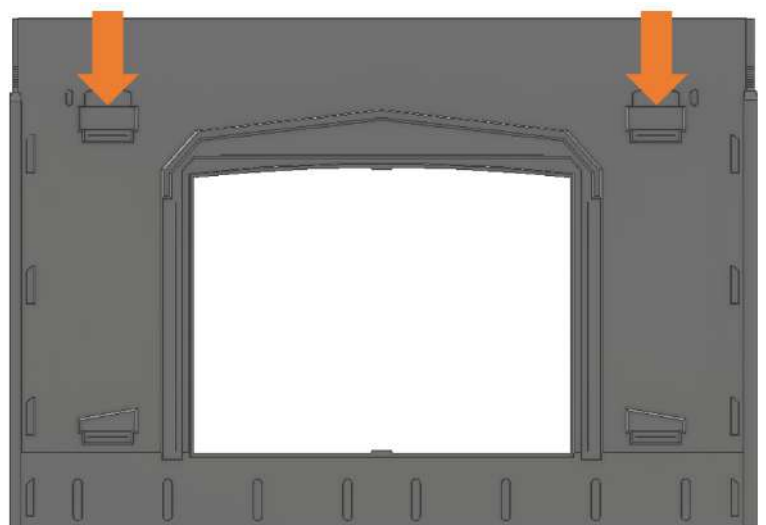

WARNING : CHECK THAT THE MODULES ARE WELL CENTERED IN RELATION TO THE FRAME SO THAT THE GRIP OF THE CLAMPS IS THE SAME ON BOTH SIDES. THE MODULE FRAME MUST ABUT AGAINST THE UPPER PADS OF THE PANEL TO PREVENT SHIFTING.

3. Installation

Stick the EPDM foam under the clamps and pre-drill them, by screwing and unscrewing to remove material.

WARNING: CHECK THAT BENEATH THE CLAMP IS DRY AND HAS NO DIRT TO ENSURE OPTIMAL BONDING OF THE FOAM.



Sticking of the EPDM foam under the fixing clamp



Pre-drilling of the EPDM foam

Attach the modules by screwing the fixing clamps at the designated positions.

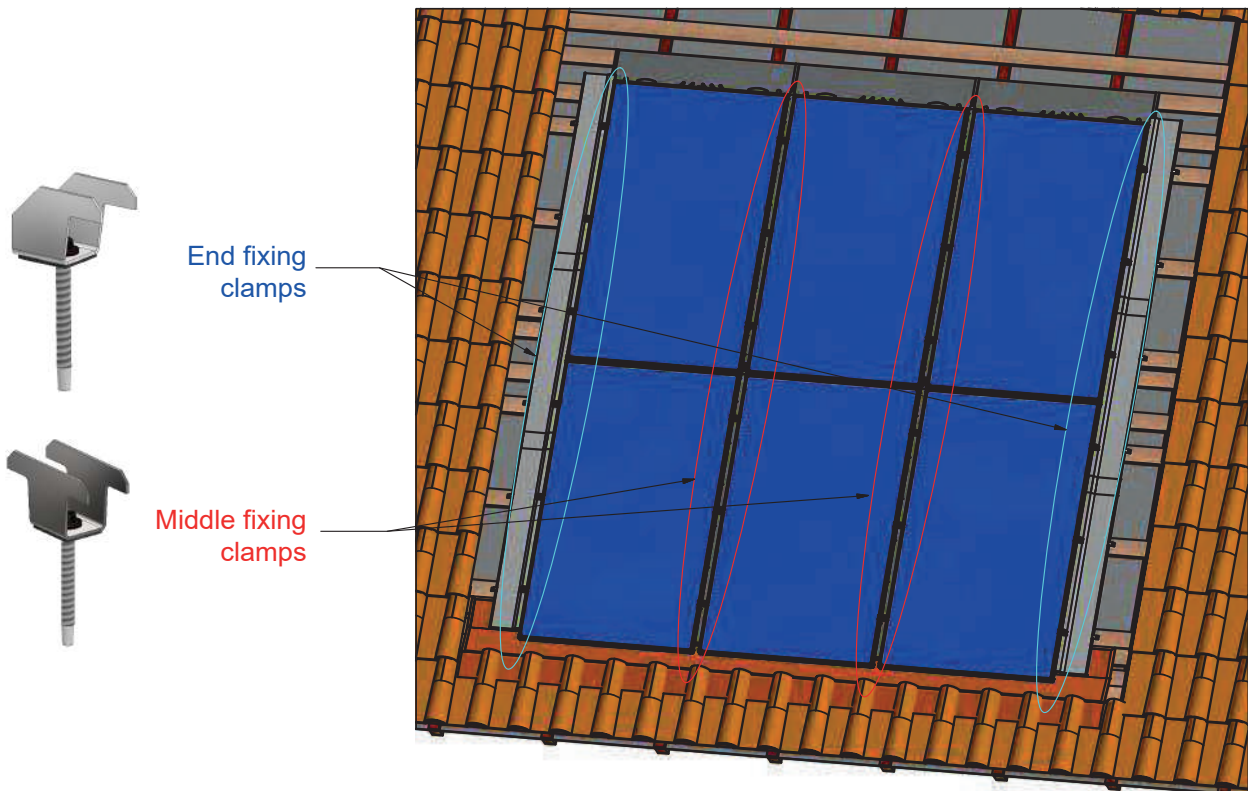

Installation of the end fixing clamps



Installation of the middle fixing clamps

3.7 Top flashings installation

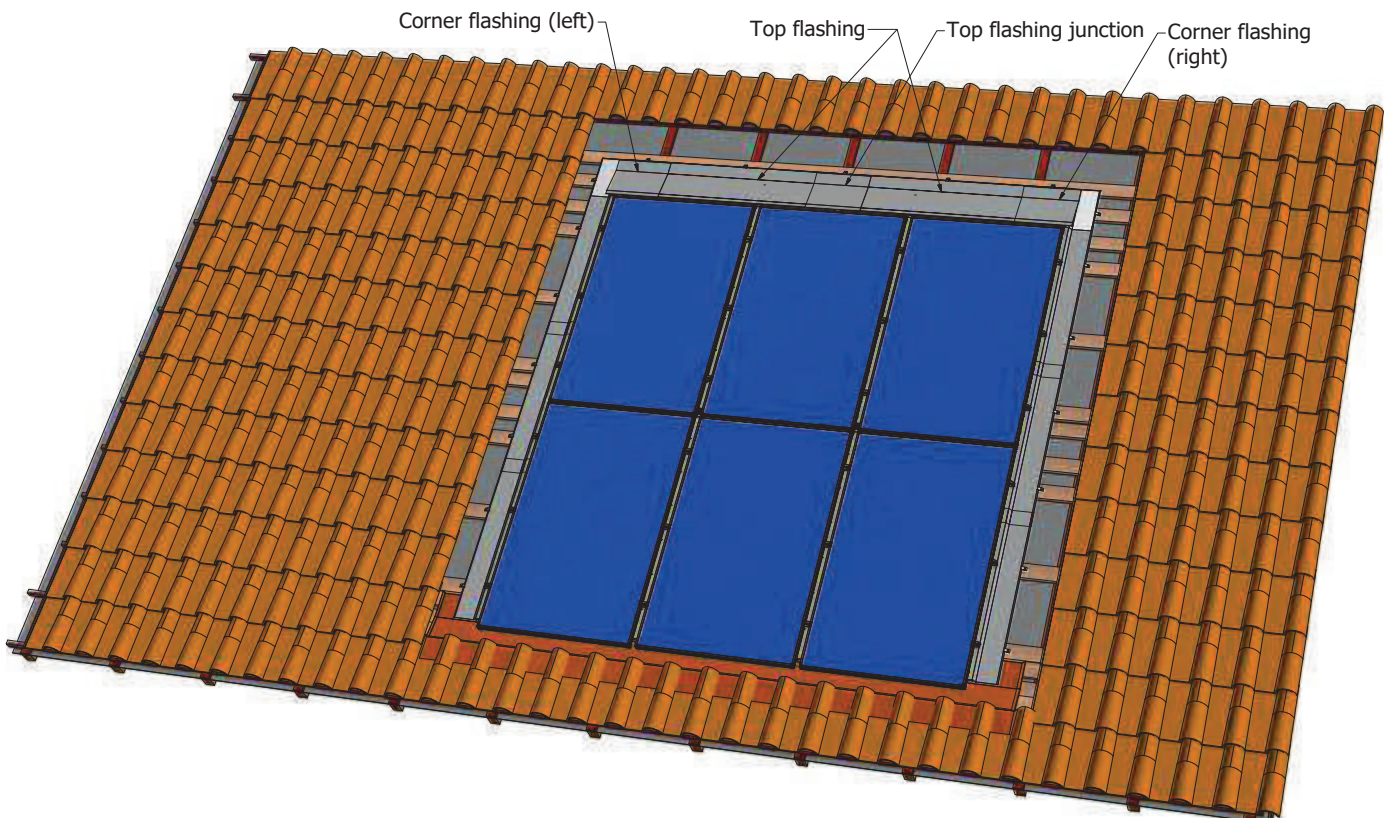

WARNING : THE TOP FLASHING PIECE IS DESIGNED WITH A SLOPE OF 14° TO ALLOW WATER FLOW ABOVE THE UPPER ROW OF MODULES. IT IS THEREFORE, ESSENTIAL FOR THE INSTALLER TO ENSURE THAT THE ROOF SLOPE IS SUFFICIENT TO PREVENT WATER RETENTION ACCORDING TO THE REGULATION.

IN BORDERLINE CASES, WE RECOMMEND THAT YOU EITHER USE A THICKER SUPPORT LATH TO DECREASE THE COUNTER-SLOPE OR TO REPLACE THE TOP FLASHINGS WITH A FLEXIBLE FLASHING STRIP (SEE BELOW).

- 1 Join the top flashings and the attach angle using pop rivets, taking care that you adjust the module frame thickness.



Pop riveting

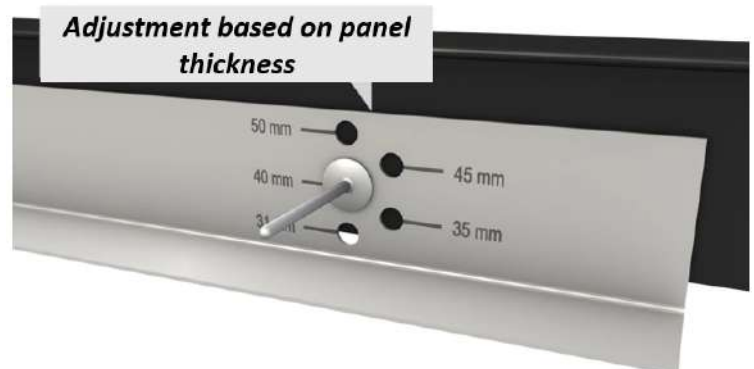

3. Installation

- 2** Position the assembly so that the module frame thickness fits between the attach angle and the top flashing.



Perfect adjustment of the assembly

Make cuts on the attach angle at the position of the GSE panel corrugations



Cut on the attach angle

- 3** Place the top junction flashing, having applied beforehand two PU glue joints on the covered top flashing area. The connecting piece must overlap with the top flashing with at least 100 mm. The gap between the top flashings should not exceed 160 mm.

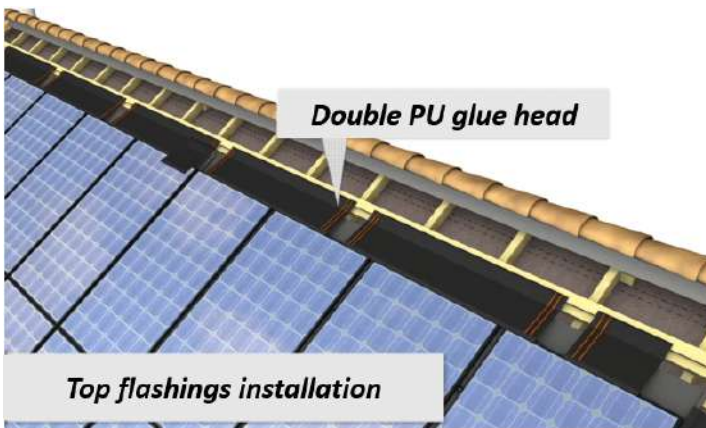

Top flashings installation

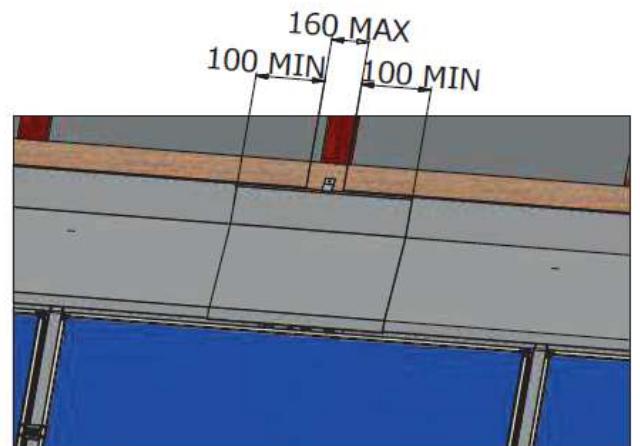

- 4** In the same way, place the corner flashings, having applied beforehand a PU glue joint on the overlapping zone of the top flashing. (Overlapping at least 100mm)

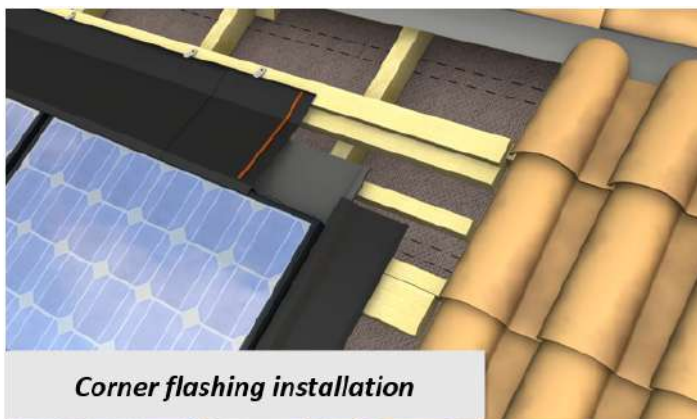

Corner flashing installation

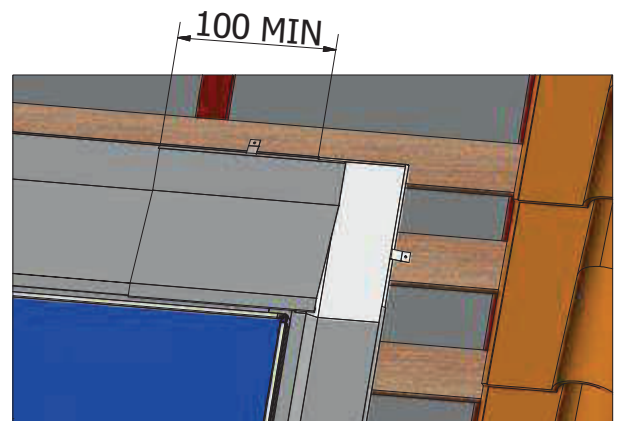

3. Installation



SPECIFIC CASE: if a gap is observed between the module and the corner flashing, cut it in order to adapt it to the thickness of the module

If needed, you will have to cut the corner flashings according to the GSE frame selected and the thickness of the module as defined in the following table:

Module thickness	30-34 mm	35-39 mm	40 et +
Frames 2012	Incompatible*	Needed cut	No cut needed
Frames 2020	Needed cut	No cut needed	Incompatible*

* Laying of a waterproofing strip on top of the PV field

GSE frames - PORTRAIT																			
	Frames v.2012							Frames v.2020											
Height Ref	1580	1575	1575	1575	1640	1640	1686	1710	1710	1710	1710	1710	1710	1710	1710	1710	1710	1710	1710
Width Ref	808	1046	1053	1082	992	1001	1016	995	1000	1005	1010	1020	1025	1030	1040	1045	1050	1055	

GSE frames - LANDSCAPE																					
	Frames v.2012											Frames v.2020									
Height Ref	1082	1082	808	992	992	992	992	992	992	992*	992*	1020	1020	1020	1020	1020	1020	1020	1020	1020	1020
Width Ref	1559	1575	1580	1640	1650	1660	1670	1675	1680	1686	1700	1665	1675	1680	1685	1690	1695	1700	1705	1720	1740

Follow the 4 steps below to cut the corner flashings:

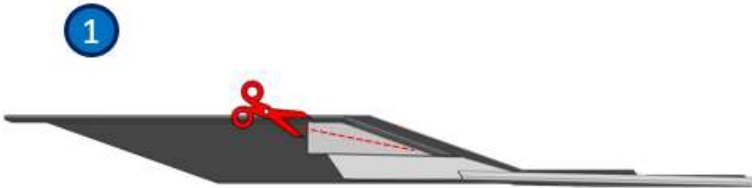

Cut the corner flashing in two distinct pieces

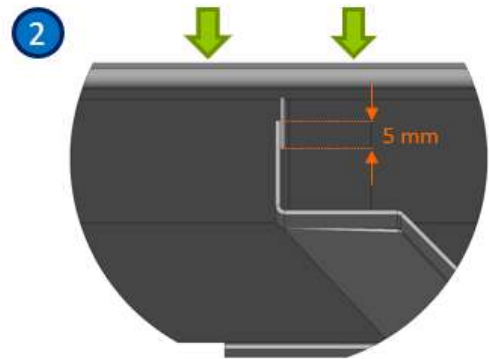

Adjust the height of the corner flashing by overlapping the two pieces



Once the height adjusted, drill the overlapped pieces with a 4,5mm drill bit

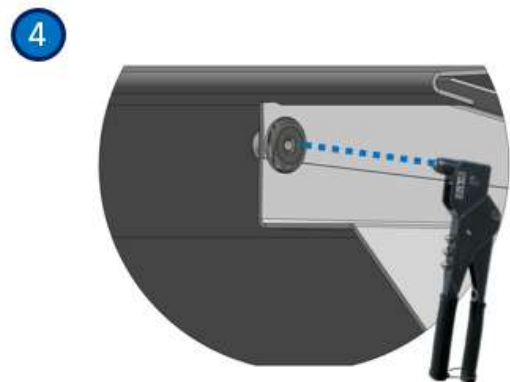

Assemble the pieces with a rivet

Once the adjustment of both corner flashings is done, install them as described in step 4, page 27.

3. Installation

5 Fix all flashings to the battens using flashing hooks (at least 2 per piece).

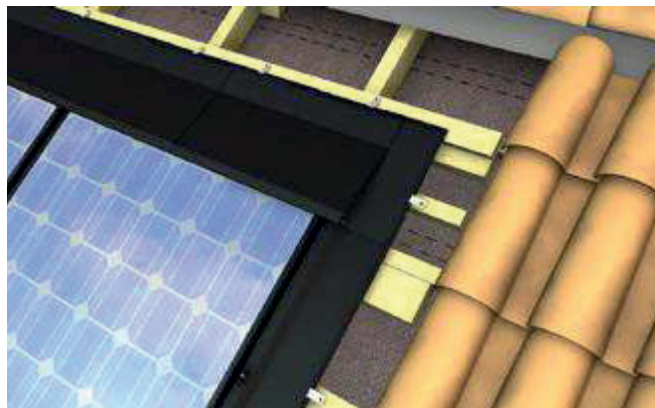
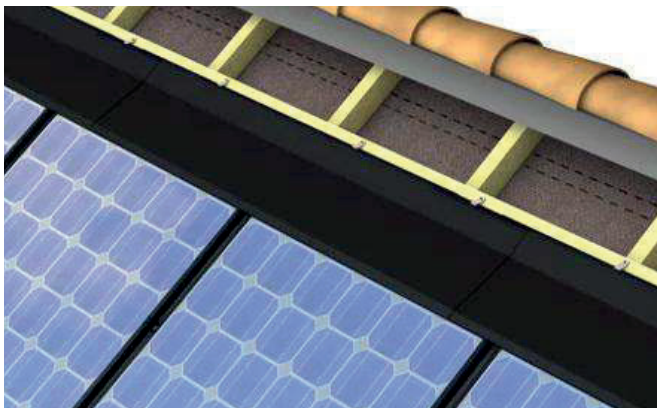

6 Place the precompressed seal on the flashings around the area on the lateral and upper parts.

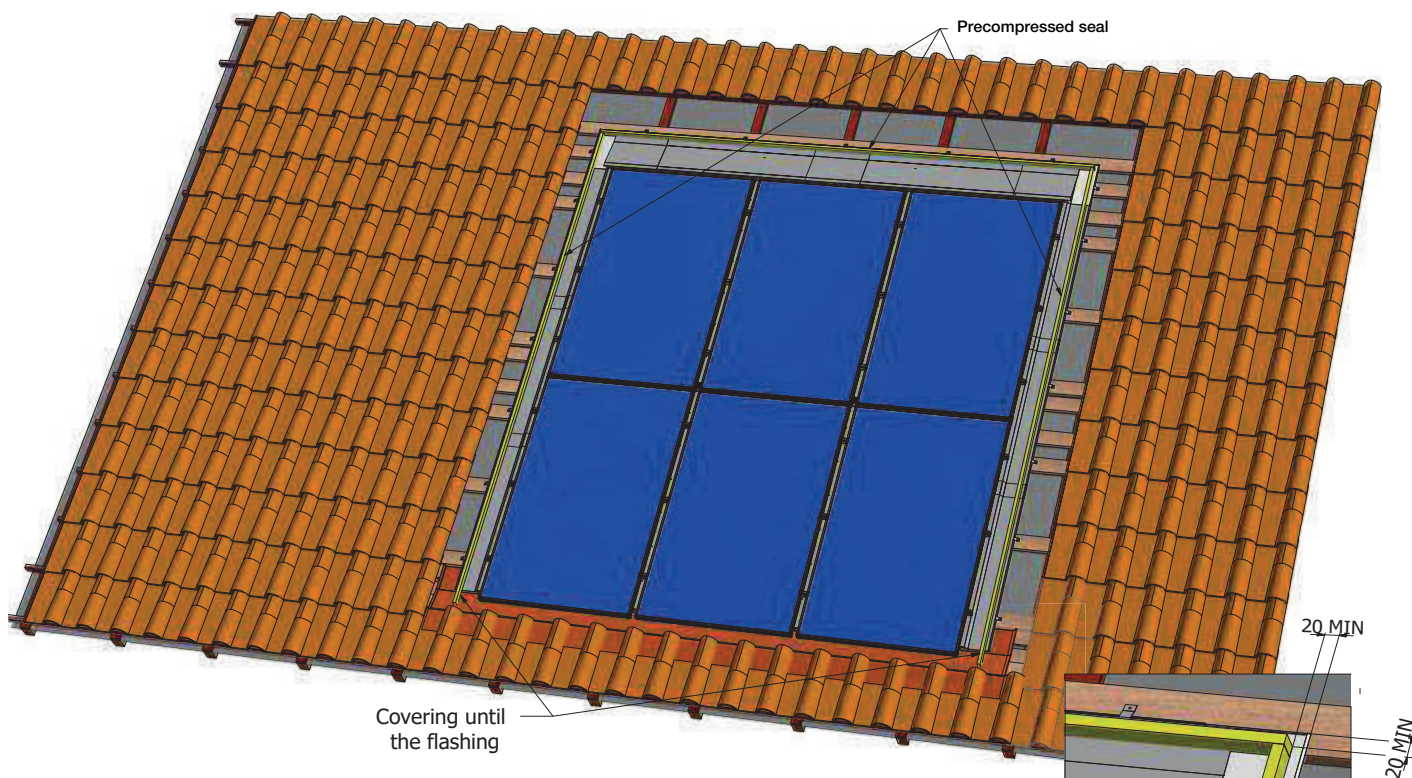

The seal must reach the bottom of the flexible flashings strip to prevent any potential infiltration of water or solid particles.

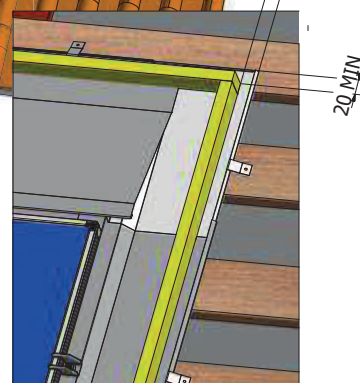

3. Installation

OPTION: REPLACING TOP FLASHINGS WITH A FLEXIBLE STRIP

It is possible to install a flexible flashing strip or equivalent to make the connection with the upper roofing elements. Shape a 2-cm fold in the upper and lateral parts of the strip to prevent any water upwelling.

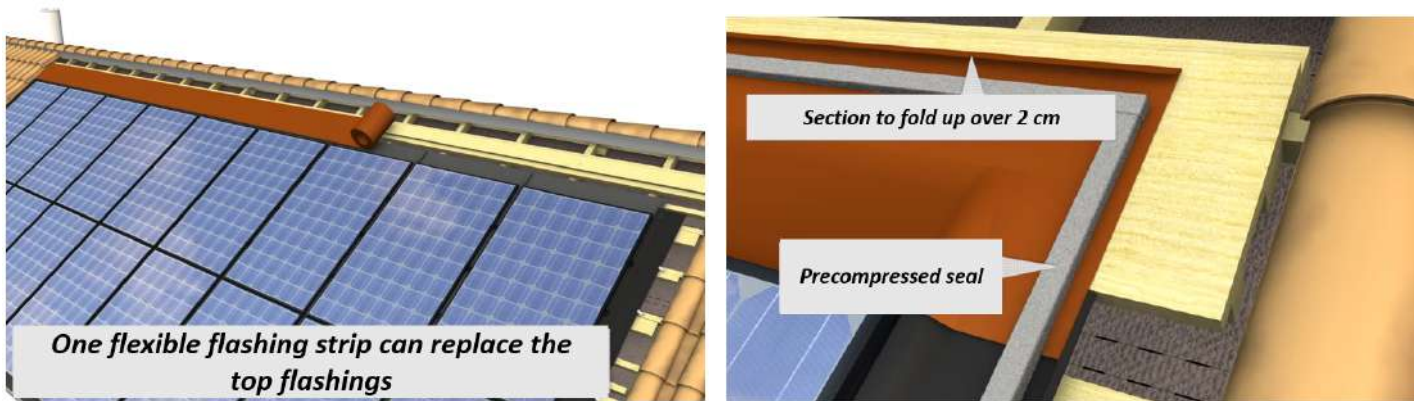

3.8 Specific case : PV array with inner/outer angles

In the case of non-rectangular PV array, inner and outer angles must be connected to the roofing using a flexible flashing strip compliant with the building/roofing regulation.

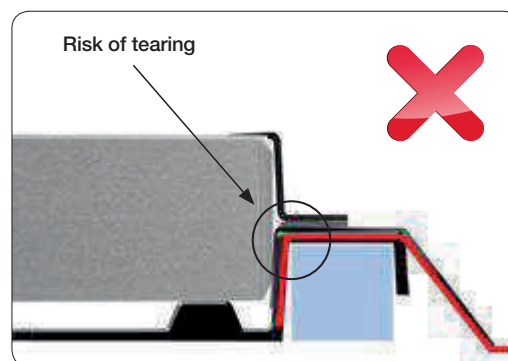
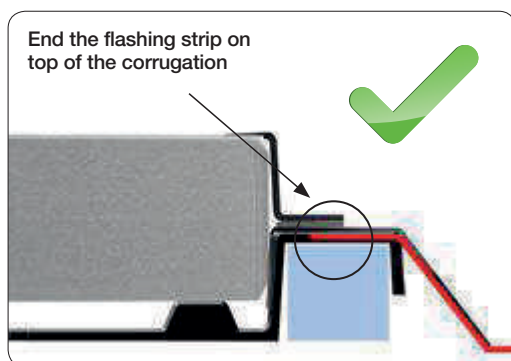
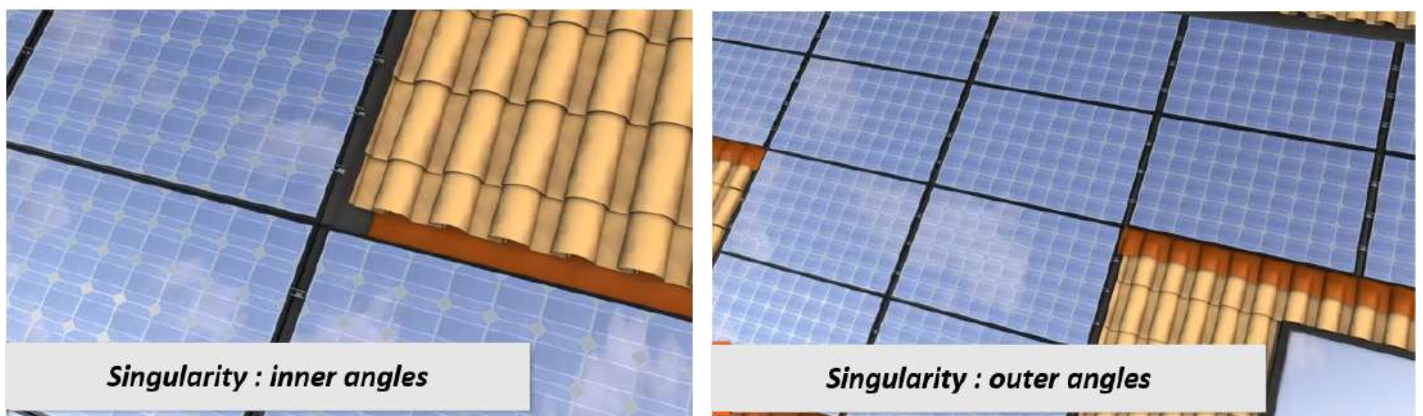

WARNING: IN BOTH CASES, THE FLEXIBLE STRIP CAUGHT BETWEEN THE FLASHING AND THE CORRUGATION OF THE GSE PANEL MUST BE POSITIONED ON TOP OF THE CORRUGATION TO PREVENT THE RISK OF TEARING.

3. Installation

3.8.1 Inner Angle (L-Shaped)

Place the flashing strip by covering the lower-row frames up to the corrugation of the adjacent frame, then cover the strip with the lateral flashing.

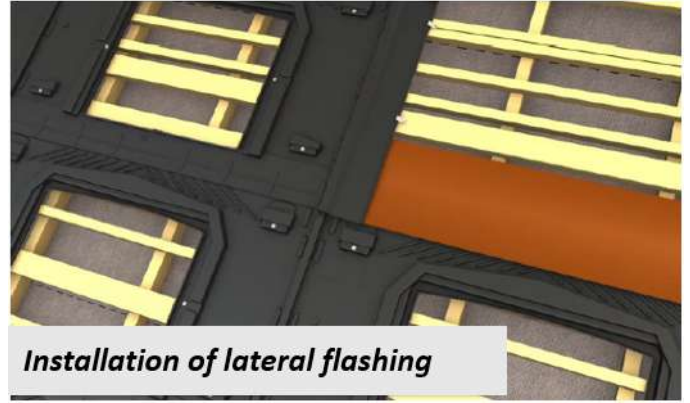
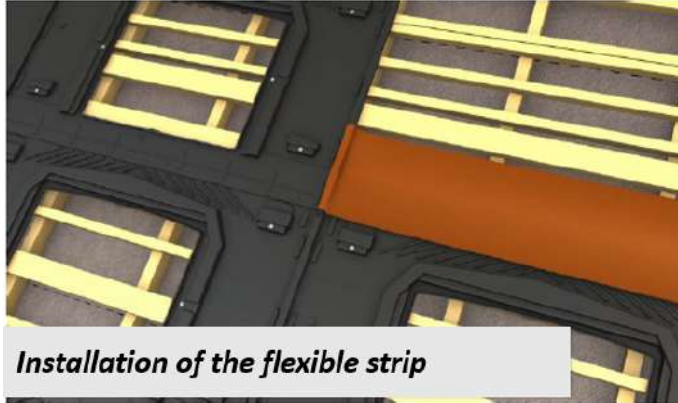

3.8.2 Outer Angle (T-Shaped)

Place the lateral flashing on the lower-row panel. Reposition the adjacent tiles to cover the lateral flashing, then place the flashing strip so that it overlaps with the last row of tiles, ensuring that there is a 2-cm fold in the upper section.

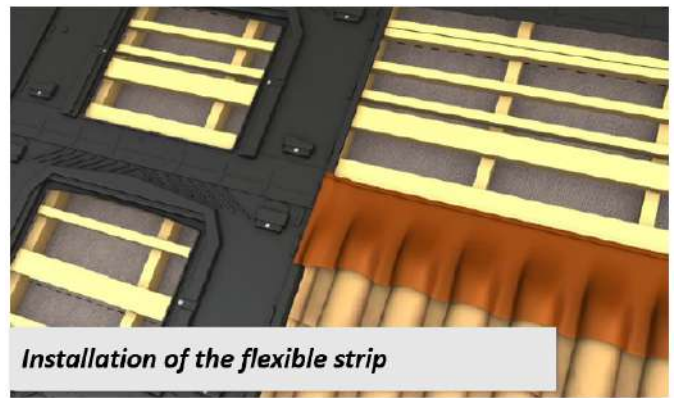
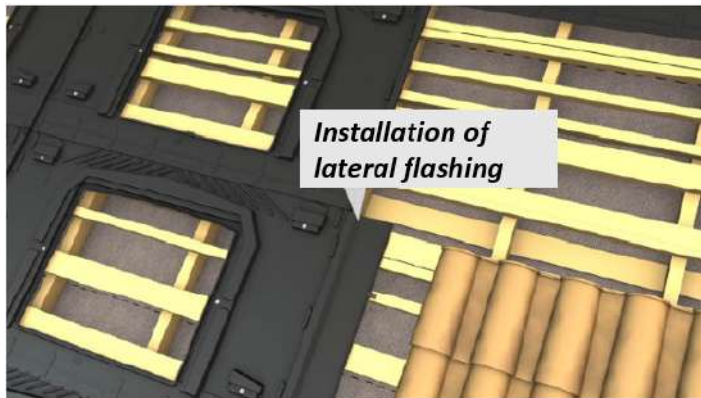

Then, position the GSE panel so that it's overlapping with the flashing strip.

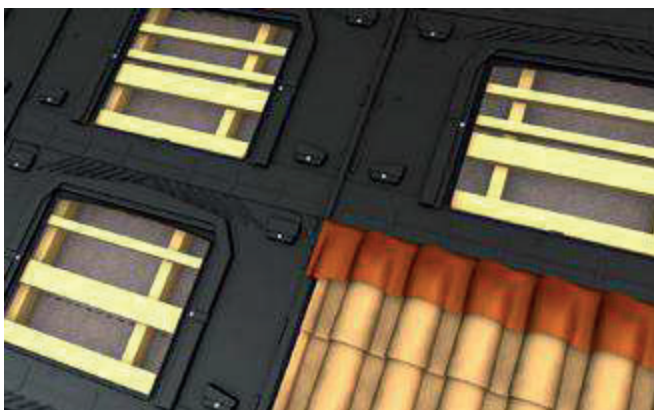

WARNING : FOR THE OVERLAP, FOLLOW ROOFING REGULATION AS WELL AS THE REQUIREMENTS IN SECTIONS 3.3 AND 3.7 OF THIS DOCUMENT.

3.9 Connection to the roof covering

Reposition the lateral and upper sections of the roofing elements to make a continuous and watertight connection with the roof.



It may be necessary to cut the tiles to ensure a compliant overlap between the elements, according to roofing regulation. These elements must be attached mechanically, as described in the roofing regulation.

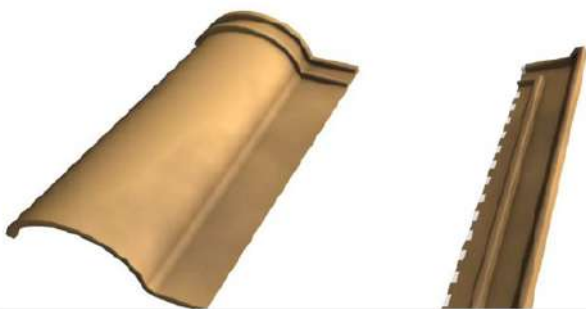

Tiles cutting for left flashing

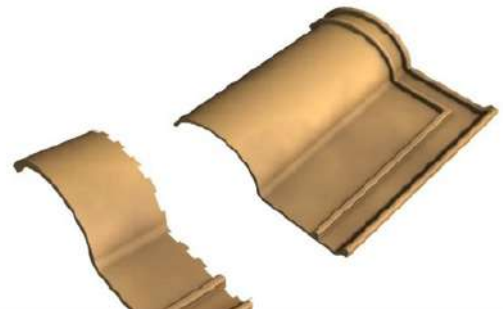

Tiles cutting for top flashing

TIP:
YOU CAN USE DOUBLE TILES OR HALF TILES FOR THE LATERAL CONNECTION.

The roof tiles must rest on the flashings with enough overlap to meet the requirements of the roofing regulation.

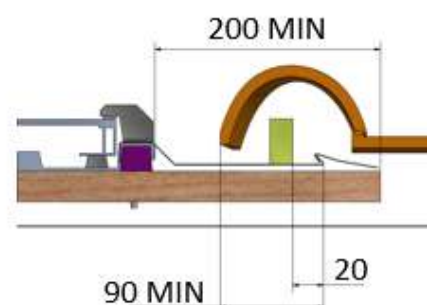
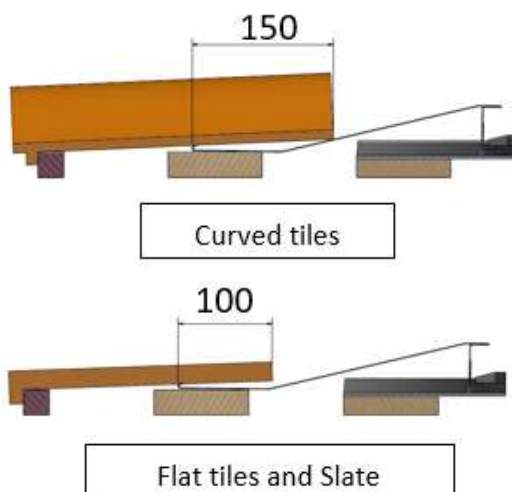

4. Maintenance and servicing

4.1 Verification

We recommend to check whether foreign materials have settled into the photovoltaic system and remove it manually if any. Simply use clean water to wash the GSE frames if needed.

For prevention, we also recommend that overall PV system installed is checked occasionally.

4.2 Module replacement

Disconnect the PV array from the AC box and proceed as follows:

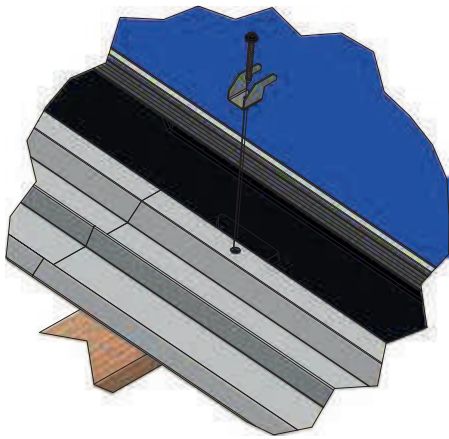

1• Unscrew the fixing clamp, remove the module and remove the edge wedges.

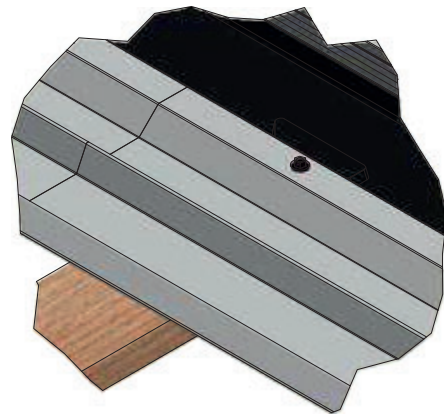

2• Screw one GSE screw at the location of old hole, having placed beforehand a new polypropylene edge wedges under the corrugation if it is located on an array edge.

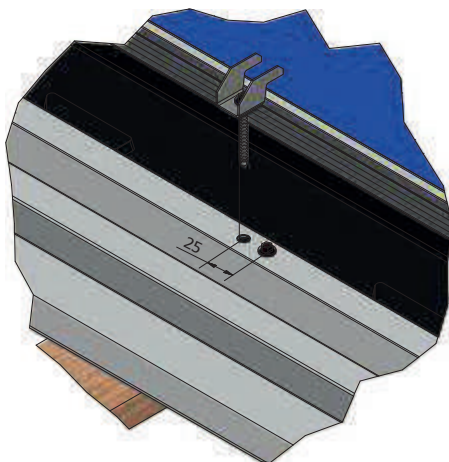

3• Make a new 10 mm hole, 25 mm above the old position.

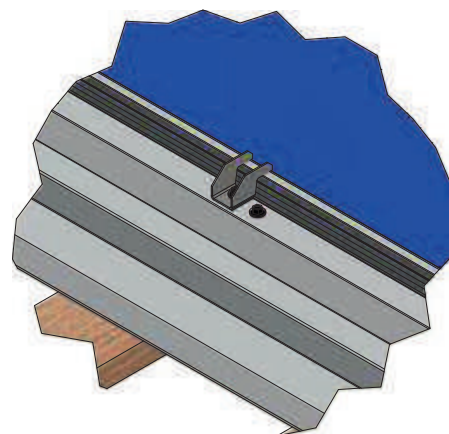

4• Place the module and attach the new assemblies (fixing clamp + EPDM foam + GSE screw).

5. Assistance and contact

5.1 Training session

9E7 ; fWcSf[a` fV\$ _ aXW`e fWUZ` [US^fCS[[Y a` fZWodaVgUf
i Z[UZ US` [U'gVWbcSUF[UWVa` VW a` efcSf[a` _ aVW`e gba`
kagddWt'gW`efi bcbh[VWV fZSf fZVWMSdWV agYZ bScf[U]bS` fež

8ad[Xad_ Sf[a` f b`V`eWUJa` fSUF kagdeS`V`e _ S` SYWladkagd
V[efqTgfaž



5.2 Technical Assistance







F75: @;53> EGBBADF ;E
3H3;>34>7 FA KAG
8DA? ? A@63K FA 8D;63K
8DA? +,% 3ž žFA (," Bž ž
/9? Fł" #,"" fi

GSE
Intégration







5 rue Morand
93400 SAINT OUEN (France)
Tel.: +33(0)1.70.32.05.05
E-Mail: contact@gseintegration.com

6. Certifications and warranties

6.1 Technical assessments

-  **ETN n°A27T2021000B0** ✓ 
-  **Avis Technique n°21-16/57** ✓ 
-  **MCS 012 – BBA 0156** ✓ 

6.2 Fire Test

-    **BRoof T1** ✓
-  **BRoof T3** ✓ 
-  **BRoof T4** ✓

GSE Intégration

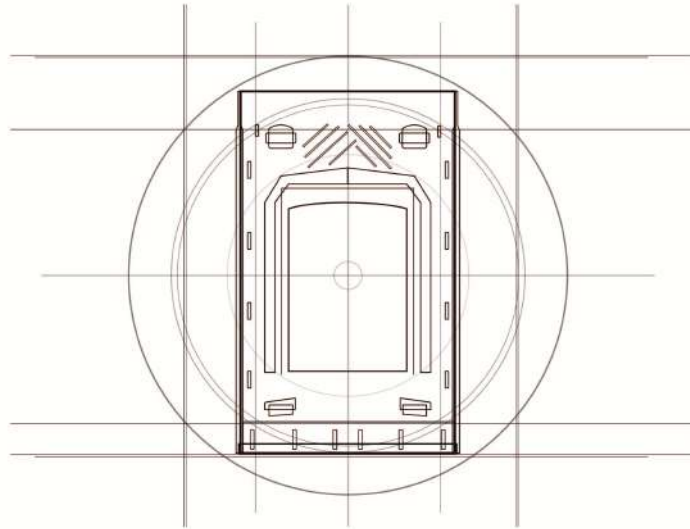

GSE IN-ROOF SYSTEM is a patented development project of
GSE Intégration

GSE
Intégration

Your distributor:

www.gseintegration.com